

Simulation of capacitive sensor for wear metal analysis of industrial oils

**Dr. Venkateswaran P
Dr. Rupa Minasamudram
Prateek Agarwal***

**Corporate Technology, Research and Technology Centre
Siemens Technology and Services Pvt. Ltd
Bangalore 560100**

*** Indian Institute of Technology-Bombay**

**COMSOL
CONFERENCE
BANGALORE2013**

Outline

- **Background**
- **Objective**
- **Simulation methodology**
- **Simulation results and discussion**
- **Experimental validation**
- **Summary**

Wear metal in industrial fluids- Introduction

- As metal surface within a machine undergoes physical and chemical wear, trace concentration of these appear in the lubricant (wear metal)
- When abnormal wear begins, larger particles in the range of 50 to 100 microns will start to be generated and gradually continue until machine failure
- Several factors affecting the oil contamination

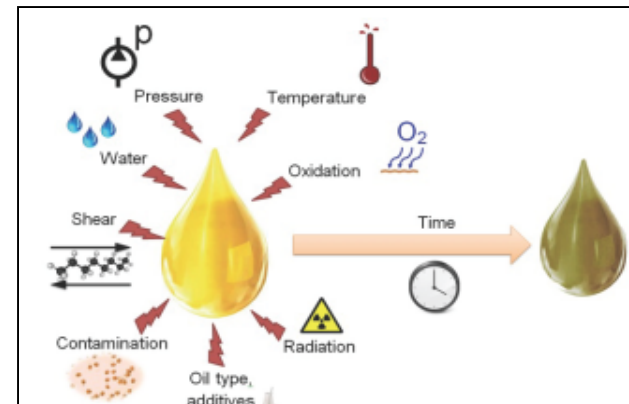

Factors affecting the oil contamination

<http://www.machinerylubrication.com/>

- Running-in: High rates of wear occur early in the cycle, during the run in stage
- Normal wear: Stabilized wear rate for normal operating period
- Failure region: As failure approaches, the bearings and gears produces greater quantities of small and large wear debris particles [1]

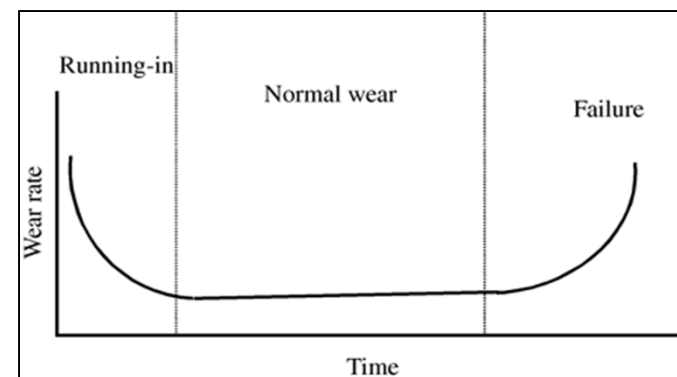

Bath tub curve

Need for condition monitoring of industrial fluids

- It has been reported that in heavy manufacturing industries, maintenance can account for as much as 40% of the total cost of the operation (example in gear drives, transformer, bearings etc.)
- Shorter machine life
- Reduced productivity
- Higher energy consumption
- Increased maintenance costs
- Environmental pollution consequences

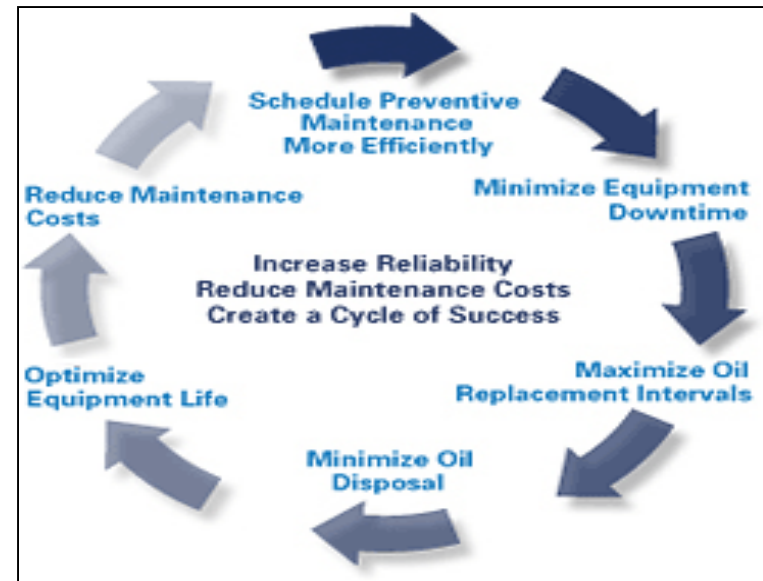

Just as a blood sample can reveal the health of a person, oil monitoring offers critical insight not only on the optimum time when the oil should be changed, but also when mechanical repairs might be necessary.

<http://www.machinerylubrication.com>

Methods for wear metal analysis

- **Capacitive sensing principle**
 - Changes the dielectric constant in between the two plates of the grid capacitor leading to change in capacitance. This change in capacitance is measured by the impedance analyzer [2,3]
- **Coulter counter principle**
 - A parallel plate MEMS capacitor based on Coulter counting principle for wear particle analysis is presented by Xia [4]
 - Capable of detecting fine wear particles in sub-micron range
- **Elemental analysis of wear metal contamination**
 - Atomic absorption spectroscopy (AAS)
 - Atomic/optical emission spectroscopy (AES/OES)
 - Mass spectroscopy
 - X-ray fluorescence spectroscopy (XRF) [5]
 - Optical UV-VIS-IR spectroscopy [6,7]
 - Ferrography
 - Magnetic chip detectors
- **Disadvantages:** Extensive pre-treatment of oil samples before analysis

Objective

- To develop a simple, easy to use, cost-effective, real-time sensor that does not need extensive sample preparation and can be easily integrated with a Programmable Logic Controller (PLC) to obtain real time data for automated analysis
- Accordingly, the goal of this work is to conduct a feasibility study on application of capacitive sensing principle and analyze different capacitor configuration for wear metal analysis using COMSOL multi-physics simulation

Electrostatics physics and stationary time independent study was conducted in Comsol

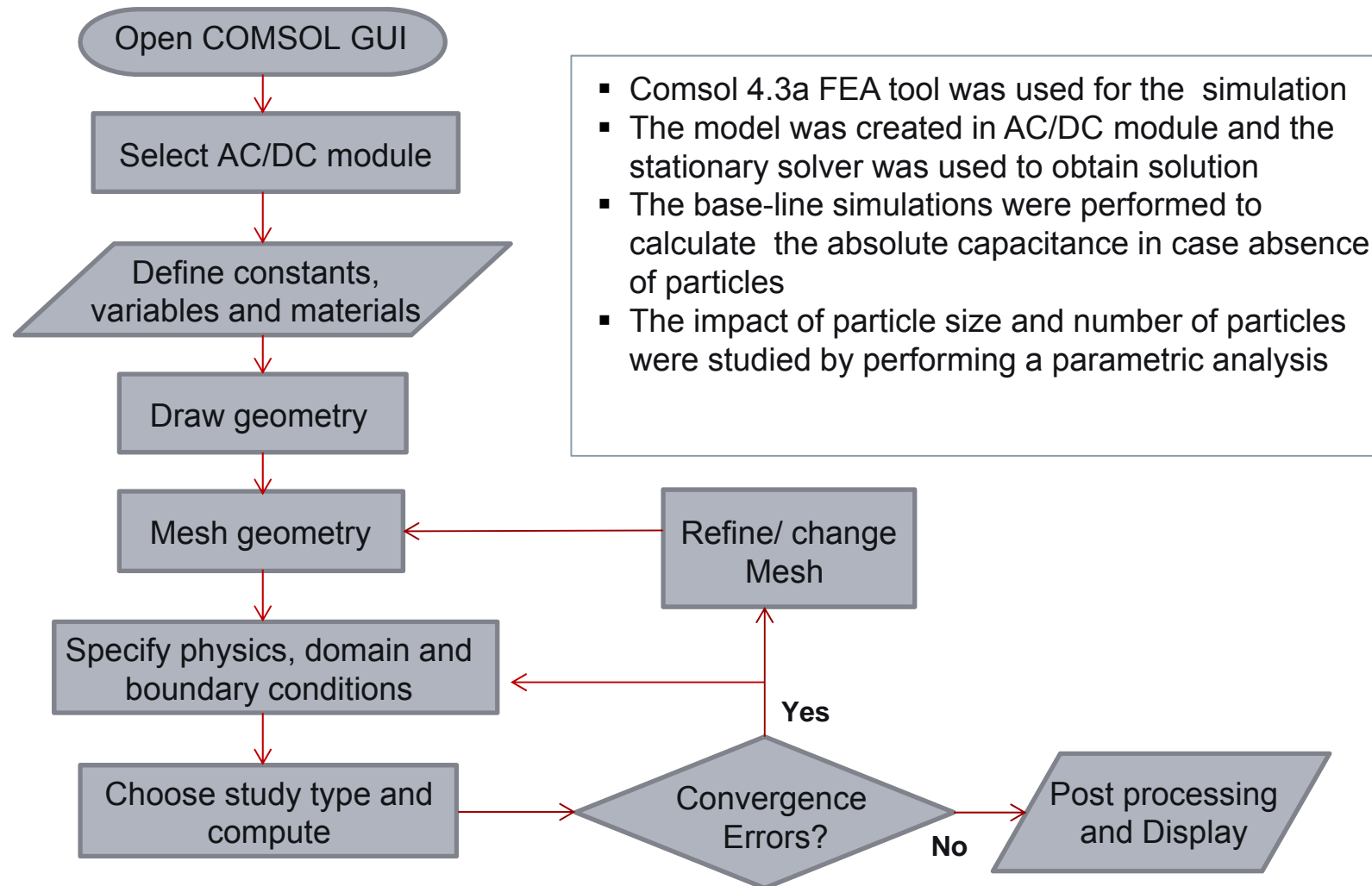

Sensing principle and physics

- The sensing principle is based on detecting change in capacitance between two plates of a capacitor due to the presence of wear metal contaminants in oil
- Polarity of oil changes due to presence of conducting metal debris inside it, which in turn leads to change in dielectric constant
- The electrostatics formulation in the AC/DC module solves the Poisson's equation to calculate the potential distribution across the field space.

$$-\nabla \cdot (\epsilon_0 \epsilon_r \nabla V) = \rho$$

Where,

ϵ_0 is the permittivity of free space, ϵ_r is the relative permittivity, and ρ is the space charge density.

- The electric field is obtained from the gradient of V .

$$E = -\nabla V$$

Geometry models of different capacitor configuration

- 3D models were built using the COMSOL GUI. The parallel plate capacitor model is based on a well-known example from COMSOL Model Library (dimensions were modified to detect particles in the range of 0.1 mm to 1 mm)
- To improve fluid flow, sensors with planar structures were considered
- A potential difference of 1 V was applied between electrodes.

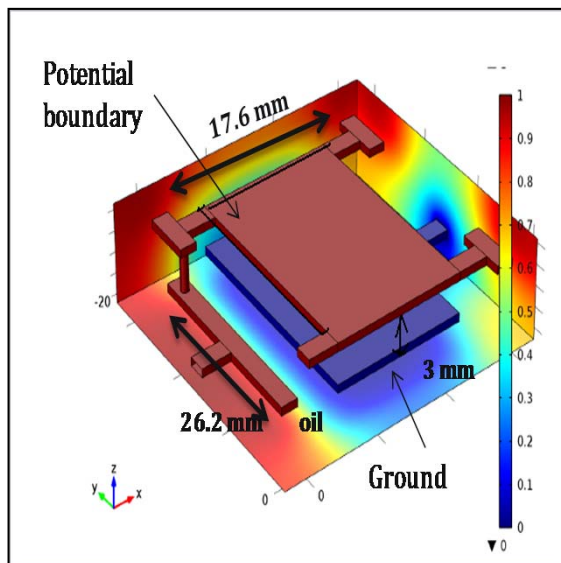

Parallel plate capacitor

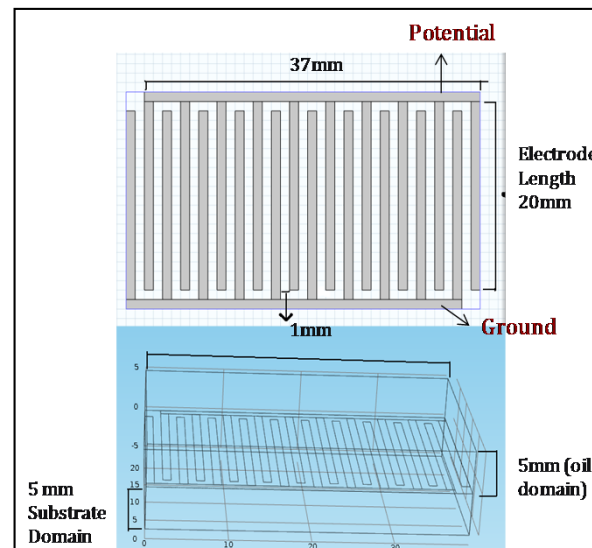

Interdigitated capacitor

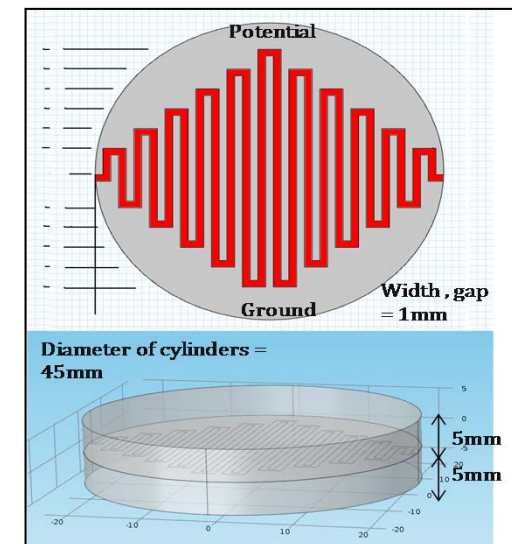

Variable finger (meandering) capacitor

Simulation results and discussion

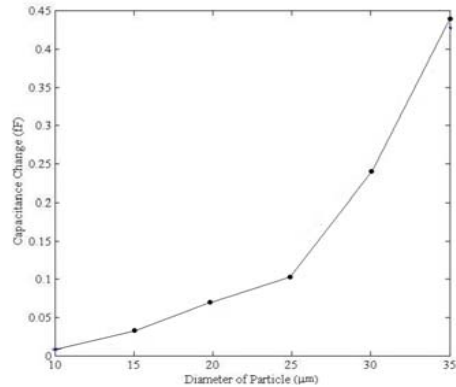

Change in capacitance with particle diameter (II plate)

No of particles	Capacitance change (pf) for IDT capacitor	Capacitance change (pf) for meandering capacitor
	Ref = 10.66 pf	Ref = 12.75 pf
3	0.05 pf	0.10 pf
6	0.11 pf	0.18 pf
9	0.16 pf	0.25 pf
12	0.20 pf	0.30 pf

Table 1: Change in capacitance with number of particles.

Parameter	Parallel plate sensor	Inter-digitated sensor	Meandering sensor
Reference capacitance	24.44 pf	10.56 pf	12.75 pf
Change in capacitance with 9 particles	0.07 pf	0.16 pf	0.25 pf
Change in capacitance with 12 particles	0.09 pf	0.20 pf	0.30 pf

Table 2: Performance comparison of parallel plate, IDT and meandering sensors.

- Capacitance change is increasing with particle diameter (concentration) for all three designs
- Change in capacitance is of the order of 0.05 pf per 3 particles for the IDT and of the order of 0.07 pf per 3 particles for the meandering capacitors
- the meandering capacitor configuration is the most sensitive (factor of 3 times that of parallel plate) to wear metal detection.

Simulation results show the meandering configuration is most sensitive among three designs

- 5 The meandering capacitor showed improved sensitivity, 3 times of that parallel capacitor

Interdigitated capacitor

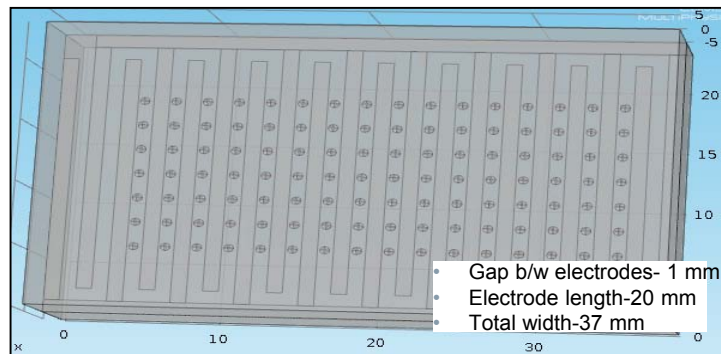

Electric potential plot

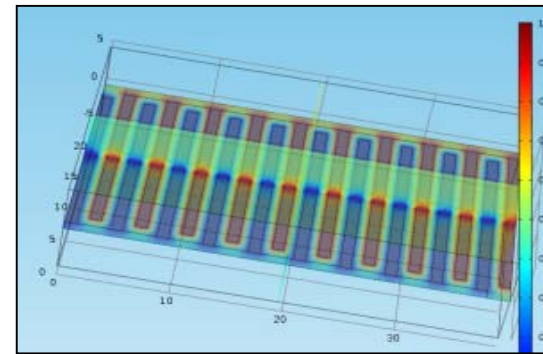

Meandering (Variable finger)

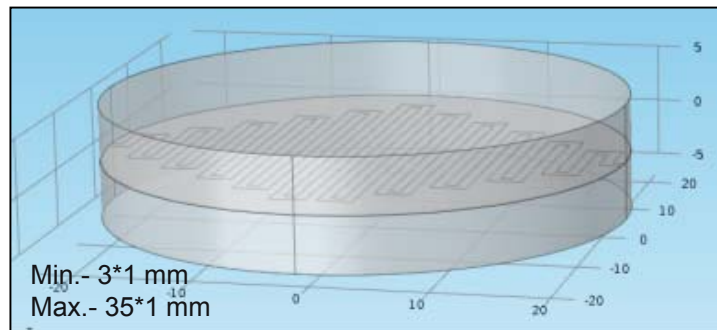

Results comparison for 3 configuration

- For 0.6 mm particle size & 12 particles in engine oil of 2.3 relative permittivity the difference in capacitance change is 0.09pF, 0.2pF and 0.3pF
- The meandering capacitor configuration is the most sensitive among all three configuration (factor of 3 time that of parallel plate capacitor)

Lab Prototype of Wear Metal Analyzer: To detect the wear metal content in contaminated oil

Lab Prototype of Wear Metal Analyzer was built using Siemens TIA, PLC and HMI

- Sensors are fabricated in FR-4 substrate
 - Fr4 is glass reinforce epoxy laminate
- A first order RC filter is realized by connecting the capacitive sensor in series
- The input signal frequency is swept from 100 kHz to 50 MHz at 5Vp-p amplitude
- The corresponding output is monitored on the oscilloscope across the 5kΩ resistor
- The sensor capacitor is placed in a vial containing 100ml of machine oil
- The condition monitoring was automated using Siemens PLC and HMI where Totally integrated Automation (TIA) protocol was used to configure the wear metal system

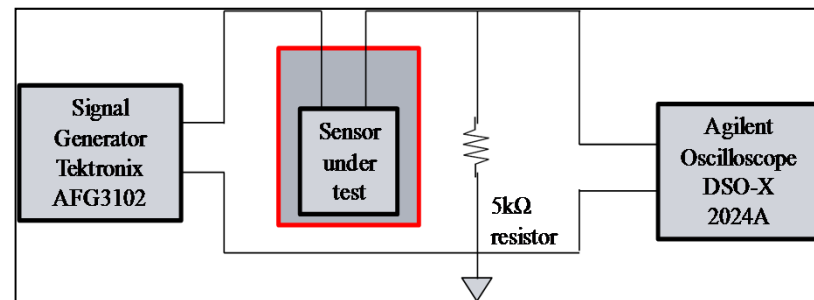

Block diagram of experimental set-up for sensor characterization

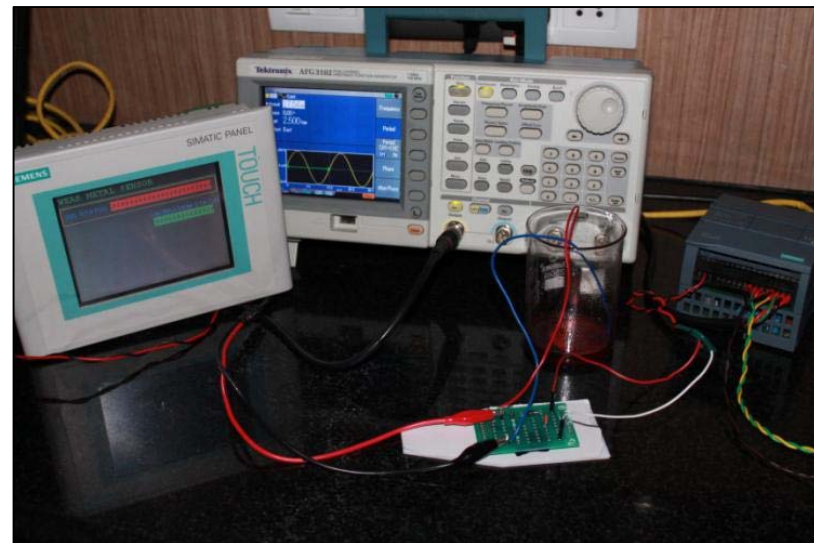

Picture of Wear Metal Analyzer lab PoC

Calibration results of Lab PoC showed that meandering capacitor has improved detection level than that of interdigitated configuration

Meandering design showed higher sensitivity than IDT at all wear metal concentrations

Sensor performance vs. frequency in ref.

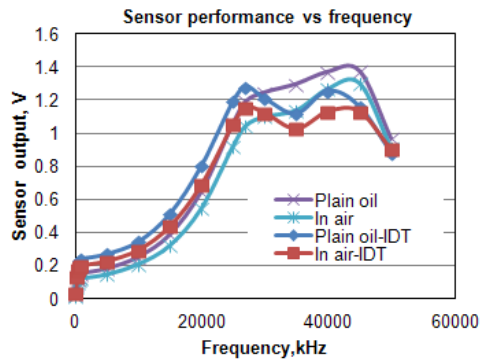

Sensor performance vs. frequency in oil

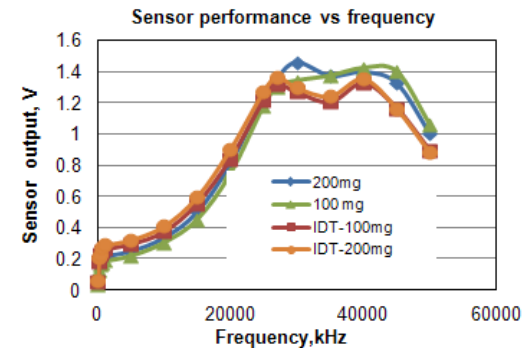

Voltage change vs. metal particle conc.

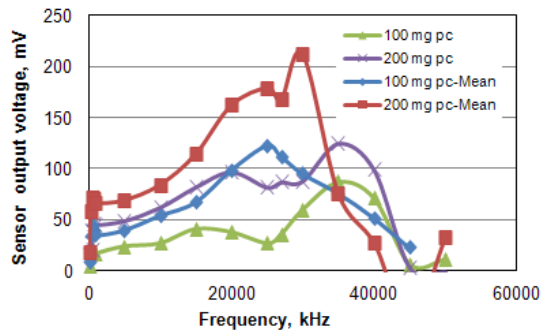

Results summary

- Sensing resolution of variable finger (meandering) capacitor is higher than interdigital configuration as similar to simulation findings
- The sensor response increases as the wear metal content is increased in weight
- Lab PoC results follow the trend predicted by the simulation

Summary

- COMSOL Multiphysics simulation studies revealed that the change in capacitance is proportional to the change in particle size as well as the particle concentration. The models were validated by comparing with published literature
- Among parallel plate, IDT and meandering capacitor designs, the later design has shown higher detection sensitivity as that of parallel plate (3 times)
- The output of the IDT sensor changed by a factor of 100 mVpp for 1g increase in metallic contamination in 100 ml volume of oil
- COMSOL has been successfully used to model and understand the behavior of capacitive sensors for wear metal detection in industrial oils

References

1. Lukas, M., and D. P. Anderson. "Analytical Tools to Detect and Quantify Large Wear Particles in Used Lubricating Oil." *Spectro Inc., MA* (2003).
2. Raadnui, S., Used oil degradation detection sensor development. *APPLIED MECHANICS AND ENGINEERING*, 11(4), 765, (2006)
3. Brown, R. W., Chung, Y., Cheng, N., Chunko, J. D., & Condit, W. C. *Novel Sensors for Portable Oil Analyzers*, Case western reserve, Univ Cleveland Ohio, Dept of Physics, (1998).
4. Xia, X. *Modeling A Microfluidic Capacitive Sensor for Metal Wear Debris Detection in Lubrication Oil*, (Doctoral dissertation, University of Akron), (2009).
5. Vähäoja, P. *Oil analysis in machine diagnostics*. University of Oulu,(2006).
6. Mignani, A. G., Ciaccheri, L., Díaz-Herrera, N., Mencaglia, A. A., Ottevaere, H., Thienpont, H. & Pavone, F. S., Optical fiber spectroscopy for measuring quality indicators of lubricant oils. *Measurement Science*, (2009).
7. Scott, Andrew J., et al. "Optical microsystem for analyzing engine lubricants." *Optics East. International Society for Optics and Photonics and Technology*, 20(3), 034011, (2004).
8. Angkawisittpan, N., and T. Manasri. "Determination of Sugar Content in Sugar Solutions using Interdigital Capacitor Sensor." 8-13, (2012).

Thanks for your attention!