

Numerical Analysis of Comfort and Energy Performance of Radiant Heat Emission Systems

Ochs^{*1}, Magni², Siegele¹ and Janetti¹

¹University of Innsbruck, ²University of Bologna

*Corresponding author: Technikerstr. 13, 6020 Innsbruck, Austria, fabian.ochs@uibk.ac.at

Abstract: Radiant heating generally addresses all heat emission systems that have a share of radiant heat emission greater than 50 %, compared to a convector or fan coil where the heat is transferred mainly by means of convection. Recently, so-called infrared-heating systems are increasingly discussed as a cost-effective heating system. Relative small areas of typically 0.6 m x 1.2 m with high surface temperatures up to 120 °C are used. In order to investigate in detail radiant heating systems, building models able to reproduce accurately the occurring physics phenomena are required. Physics-detailed steady state and transient room models have been developed in Matlab®. The required view factors for the radiative exchange between all surfaces and between each surface and a sphere representing a person are calculated using COMSOL Multiphysics®. Moreover, the thermal comfort in different positions of the room has been evaluated.

Keywords: Radiant Heating, View Factor, Building Simulation, NZEB, Passive House

1. Introduction

The implementation of the concept of NZEB [1] will lead to a further reduction of the heating demand of new buildings. Also the heating demand of the building stock will decrease by applying deep renovation. The technology to achieve very low energy demands is available since about 25 years, when the first Passive House was built in Darmstadt, Germany [2]. Technology and products have been further improved since then and cost-effectiveness has been significantly improved. However, in order to improve the economic feasibility of these very efficient buildings, cost-effective heating systems are required. In parallel the share of renewable energies (such as PV or wind) in the electric grid will further increase. Both these developments make electric heating interesting again in spite of the fact that, because of

thermodynamic principles, electricity should not be used for heating.

2. Motivation and Objective

Recently so-called infrared-heating systems are increasingly discussed as a cost-effective heating system. Relative small areas of typically 0.6 m x 1.2 m with high surface temperatures of up to 120 °C are used. The following questions have to be answered:

What is the appropriate dimensioning of the radiant system depending on the load of the building?

What are the comfort conditions with radiant heating systems and how should they be determined and evaluated?

What is the energy performance compared to reference systems such as hydronic heat emission systems e.g. with air-sourced heat pump?

Is there a benefit in intermittent operation due to the relative fast response of these heating systems?

3. Radiative Heating - Definition

With a convective heat emission system, such as e.g. a convector or a fan coil, thermal energy is emitted mainly convectively (either through free and/or forced convection) directly into the air. Contrariwise, with a so-called radiative heat emission system, i.e. a heated area where min. 50 % of the heat emission occurs as long-wave radiation, the major share of the heat is distributed to the surrounding surfaces. Radiation heat emission systems are in principle independent of the type of heat supply (i.e. electrical or hydronic), however, often electrically heated systems are addressed (infrared heating system). Remark: The so-called supply air heating in a Passive House is with regard to the supply air rooms also a radiant heating system. The warm supply air flows close to the ceiling due to the Coanda effect [3]. In turn the ceiling is heated up in an area close to

the air outlet and, consequently, it emits heat as long-wave radiation to the other surfaces.

In case of a radiant heat emission system, the temperature of the surrounding surfaces increases compared to a predominantly convective heating system, assuming the same heating power. As a consequence, a lower convective (i.e. air) temperature is required for the same operative temperature, which consists of about 40 % to 50 % of the convective temperature and 50 % to 60 % of the surface temperature of the surrounding areas. This means for the energy balance of a room, that with a radiant heating system compared to a convective heating system the same thermal comfort can be obtained with slightly reduced ventilation losses, but also slightly increased transmission losses (especially when the radiant heater is mounted on an external wall or when external walls form the radiation partner of the radiant heater). In buildings with very high quality of the thermal envelope, the increase of the transmission losses is almost negligible (unless the direct radiation partner is a window). In case of very efficient buildings, as demanded by the EU energy performance of buildings directive (EPBD [4]), the ventilation losses are also low (due to the heat recovery required for achieving high thermal comfort and low heating demands), hence, also the reduction of ventilation losses is of minor importance. Decreased and increased losses are more or less balanced. The difference of the heating demand between a radiant and a convective heating system increases with better quality of the building envelope and higher energetically effective air exchange rate (the equivalent air change that is not covered by the heat recovery). In case of poor quality of the envelope the energy consumption for heating can even increase compared to a convective heating system.

4. Thermal Comfort

The radiant temperature asymmetry (half-space and small hot surfaces) has to be considered when dimensioning a radiant heat emission system. The ISO 7730 [5] (as well as the ASHRAE 55 [6]) specifies a maximum radiant temperature asymmetry of 5 K for heated ceilings and 23 K for a heated wall. More recent studies, such as e.g. [7] indicate slightly higher values with about 8 K for heated ceilings. Here,

it is important to note that slightly different results might be obtained for the heating demand depending on whether optimal thermal comfort at the most unfavorable location in the room or in average with respect to the occupied area is demanded. For a meaningful comparison, equal room air quality and equal thermal comfort are prerequisite.

In addition to the potential energy savings due to reduced ventilation losses, there is a further reduction potential due to the possibility to provide thermal comfort only locally. This can refer to a specific place in the room (e.g. the working place) or on separate heating of the occupied areas (in contrast to heating the entire inhabited space). A correct sizing and a temporally and spatially correct functioning control of the radiant heating system is a prerequisite to achieve thermal comfort.

5. Modelling and Building Simulation

A building model with a detailed calculation of the radiation exchange (between each of the surrounding surfaces, as well as between all surrounding surfaces and a sphere (or ellipse or cube), simulating a person in the room and used for calculating the operating temperature) is required to represent these effects with sufficient accuracy. With such a model, the effects can be determined with higher accuracy compared to a two-star e.g., Dynbil [8], Energy+ [9]) or star node e.g. EN ISO 13790 [10], TRNSYS [11] model that are usually used for building simulations [12, 13].

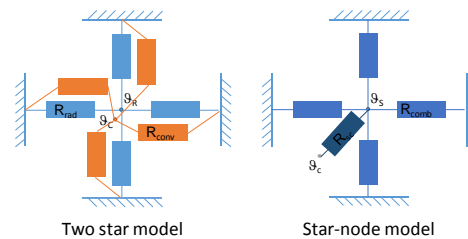

Figure 1. star-node model (right) and two-star model (left) with four surfaces: ϑ_r radiative node, ϑ_c convective node, ϑ_s star node (mixture of surface and air temperature), R_{rad} radiative resistance, R_{conv} convective resistance, R_{comb} combined radiative and convective resistance and R_{sc} the resistance between the star node and the convective node

With such a detailed physical model of a room a possible influence on the heating demand with a radiant heating system compared to a convective heating system can be calculated depending on the building standard (i.e. the quality of the building envelope and the energetically effective air exchange rate). Here, a low linear temperature stratification in the room (i.e. an ideal mixing) is assumed, see Fig. 2. This assumption is acceptable in rooms with very good insulation level and ventilation with heat recovery. However, it will not hold in case of radiant ceilings and/or cold air supply. For a more accurate analysis, in addition, a computational flow simulation (CFD) for determining the temperature stratification would be needed. The convective heat transfer coefficients are calculated with well-known power law correlations, see [14]:

$$h_{conv} = C \cdot \Delta \vartheta^n \quad (\text{eq. 1})$$

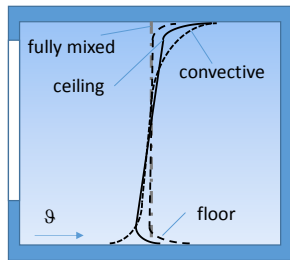

Figure 2. Temperature stratification for different heating situations, ceiling and floor heating, convective heating and fully mixed

6. Physical Room Model

Detailed steady state and transient physical room models have been developed in Matlab® based on the radiosity approach [13, 14, 15], see Fig. 3. The required view factors for the radiation exchange between all surfaces and between each surface and a sphere representing a person or a thermal comfort in different positions of the room are calculated using COMSOL Multiphysics® software, see section 6.1.3 for details. H_i is the radiosity. The resistances R_{ij} can be calculated with the view factor F_{ij} the area A_i and r_i is the emissivity resistance.

$$R_{ij} = \frac{1}{A_i F_{ij}} \quad (\text{eq. 2})$$

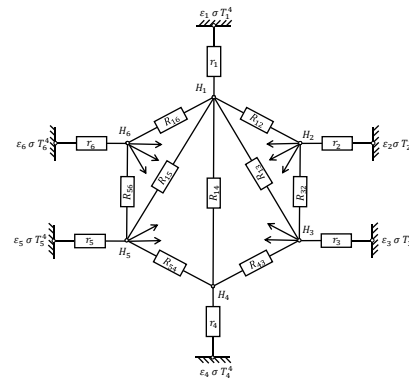

Figure 3. Model for long-wave radiation exchange with 6 surfaces

6.1. View Factor Calculation

The view factor F_{ij} represents the fraction of the radiation which leaves the surface A_1 and strikes the surface A_2 , as shown in Fig. 4.

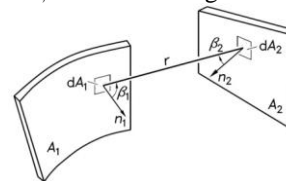

Figure 4. Calculation of View Factor [15]

6.1.1 Analytic Calculation of View Factors

If the radiation intensity is constant over the surface the view factor can be calculated analytically by solving eq. 3. the view factor F_{12} does not depend only on the geometrical configuration.

$$F_{12} = \frac{1}{\pi A_1} \iint_{A_1, A_2} \frac{\cos \beta_1 \cos \beta_2}{r^2} dA_1 dA_2 \quad (\text{eq. 3})$$

For many simple geometries view factors are available in the literature, e.g. in [15, 16]. For complex geometries numerical methods have to be used. If the surfaces radiate diffusely, have constant temperature and radiation properties over the entire area numerical integration can be applied.

6.1.2 Numerical Integration

In Matlab® CDIF (contour double integral formula) can be used to calculate view factors between planar surfaces (i.e. polygons) for any shape and orientation e.g. with [17].

6.1.3 View Factor Calculation with COMSOL Multiphysics®

In COMSOL Multiphysics® surface to surface radiation problems can be solved using the radiosity approach with the irradiation G (here G is the mutual irradiation coming from the other boundaries), the radiosity H and the emissivity ε :

$$(1 - \varepsilon) \cdot G = H - \varepsilon \cdot \sigma \cdot T^4 \quad (\text{eq. 4})$$

The emissivity can be a function of wavelength (λ) and surface temperature (T). Complex geometries also with obstructions can be considered. But the hypothesis of diffuse grey surface has to hold i.e. every surface has the absorption coefficient equal to the emissivity coefficient and emissivity and absorptivity are independent of the angle of emission or absorption, respectively.

Here, two different methods are studied and compared:

1) Surface to surface radiation physics, where it is necessary to run one simulation for every view factor which has to be calculated. The COMSOL® operators $\text{radopd}(H_{\text{up}}, H_{\text{down}})$ and $\text{radopu}(H_{\text{up}}, H_{\text{down}})$ are used.

2) Heat Transfer with Surface-to-Surface Radiation physics where surfaces are presented as solid objects.

$$H_i = -\dot{Q}_i \frac{(1 - \varepsilon_i)}{\varepsilon_i A_i} + \sigma \cdot T_i^4 \quad (\text{eq. 5})$$

6.2 Validation

For a room with 6 surfaces, the view factors are calculated with the three numerical methods (numerical integration with Matlab® and the two methods using COMSOL®) and are compared against the analytical solution. For six surfaces, there are 36 unknown view factors. Considering that the surfaces are plane and there are symmetries and applying reciprocal conditions the unknowns are reduced to four. With one simulation with COMSOL method 2, for six surface temperatures six heat fluxes are determined. The remaining linear system of equations can be solved, e.g. with Matlab®. The view factors of the analytical solution are reported in the Table 1. Maximum deviations for each case are summarized in Table 2.

Table 1: View factors for the six surface problem

	(1)	(2)	(3)	(4)	(5)	(6)
(1)	0	0.1125	0.1257	0.1125	0.3246	0.3246
(2)	0.1500	0	0.1500	0.0668	0.3166	0.3166
(3)	0.1257	0.1125	0	0.1125	0.3246	0.3246
(4)	0.1500	0.0668	0.1500	0	0.3166	0.3166
(5)	0.1461	0.1068	0.1461	0.1068	0	0.4942
(6)	0.1461	0.1068	0.1461	0.1068	0.4942	0

Table 2: Max and mean deviations with respect to the analytical solution

	COMSOL® Method 1	COMSOL® Method 2	Numerical integration (Matlab®)
Max	6.14089E-06	0.09540322	4.08681E-06
Mean	1.7281E-06	0.03366432	2.14461E-06

Numerical integration with Matlab® and COMSOL® Method 1 deliver sufficiently accurate results with respect to the analytical solution. The reason for the deviations in case of the method 2 has to be further investigated. The main advantage of using COMSOL® for the determination of the view factors is that the problem can be coupled to further physic problems such as CFD simulations.

7. Case Study

7.1 Description

For a simple room model with the dimensions 8 m x 6 m x 2.7 m (WxDxH) the theoretical change of the heating power and the (annual) heating demand were calculated exemplarily. The room has one external façade with a share of window surface of 30 % (or 60 % as a variant) and an external ceiling (insulated flat roof, or adiabatic as a variant) each in Passive House quality. Different sizes and positions of the radiant heater have been investigated, (see Table 3) and compared against the reference case with convective heating.

Table 3: Investigated cases – position and size of radiant heater centric (c) and acentric (ac), see Fig. 5

	Large	Medium	Small c.	Small ac.
Side wall	x	X	x	x
Rear wall	x	X	x	x
Floor	x	x		
Ceiling	x	x	x	x

Figure 5 shows a scheme of the case with small radiant heater centered and acentric and Figure 6 shows the corresponding spatial distribution of the radiative temperature in 1.5 m height as a result of a steady state calculation for an operative temperature of 20 °C.

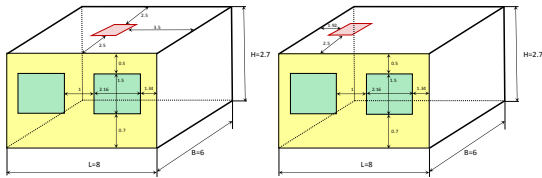

Figure 5. Scheme of small radiant heater centered (left) and acentric (right).

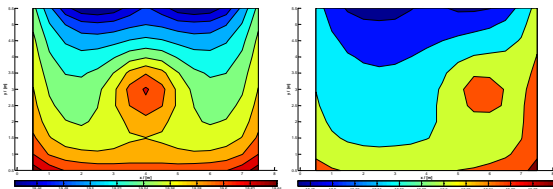

Figure 6. Spatial distribution of the radiation temperature in 1.5 m height for the small radiant heater centered (left) and acentric (right)

7.2 Results

The calculated reduction of the heating demand depends on the energetically effective air exchange rate see Fig. 7.

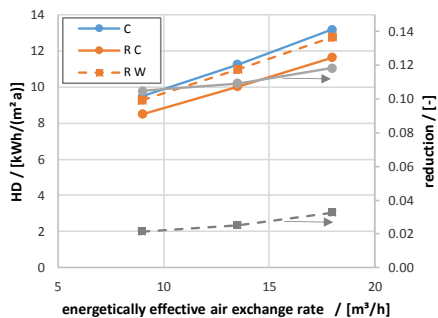

Figure 7. Heating demand (HD) for the small radiant heater on the ceiling (R C) and wall (R W) and reduction with respect to convective heating (C) depending on the energetically effective air exchange rate

It is in case of a specific heating demand (HD) of about 10 kWh/(m² a) corresponding to an air change rate of 60 m³/h with heat recovery with an effectiveness of 85% (with correspondingly very low energetically effective air exchange rate of only 9 m³/h) in the range of

10 % for a small ceiling mounted radiant heater and 6 % for a small wall mounted radiant heater (each with 1 m²), see Table 4. The reduction results from the fact that good thermal comfort in this constellation is given only locally. For the same temporal and spatial comfort, no significant differences between a predominantly convective heat emission system and one which emits predominantly long-wave radiation can be determined within the model accuracy. Differences in the heating demand, which are based on differences in local comfort cannot be valued as energy savings. The radiant temperature asymmetry is in case of the small ceiling mounted radiant heater at the limit of the thermal comfort range. The maximum radiant temperature asymmetry permitted according to ISO 7730 is 5 K and can be exceeded with a small radiant heater with correspondingly high surface temperature.

Considering that, in case of a comfort ventilation, the air is further heated in the exhaust air rooms (especially in the bathroom, where according to the standards a temperature of 24 °C should be maintained), the difference between predominantly convective heat emission and radiative heat emission is likely to be further reduced in reality, i.e. the calculated difference will be lower when related to the entire building.

Table 4: Heating Demand (HD) for different sizes and positions of the radiant heater compared to pure convective heating, climate of Innsbruck

Case	HD / [kWh/(m² a)]
Convective	10.2
Floor Heating (large)	10.7
Ceiling Heating (large)	10.5
Ceiling Heating (small)	9.1
Wall Heating (small)	9.6

With large radiative surfaces the possibility of providing local comfort is limited and the reduction of the ventilation losses is (over-) compensated by increased transmission losses. For an increased effective air exchange (i.e. in the case of window ventilation or an exhaust air system) the difference of the heating demand would be theoretically larger, however the heating demand would then have an order of magnitude such that an electric heater as a sole heating system cannot be recommended. It must be further noted that without heat recovery, due to cold air drop and due to the high radiant

temperature asymmetry, thermal comfort cannot be provided. A radiant heating system as a sole heating system is generally not recommended without heat recovery. Without heat recovery, a convective heating part is required to preheat the occasionally very cold fresh air in order to avoid cold air drop and cold air stratification.

8. Discussion

The savings potential is relatively low with respect to the heating demand. However, not only the heating demand, but the entire production, transport and storage chain must be considered in a comprehensive comparison, i.e. eventually, the primary energy consumption of the whole building must be compared. It has to be taken into account that heat storage and distribution losses can occur with conventional heating systems, if they are placed outside the thermal envelope.

Compared e.g. to an air heat pump heating system, which generally has a relatively low seasonal performance factor (SPF) of around 2 to 3 for heating due to low air temperatures in winter, the electricity and primary energy demand is higher for an electric radiant heating system even taking into account all thermal losses. Assuming a specific heating demand of 15 kWh/(m² a), 10 % reduction of the heating demand in the case of radiant heating system and 10 % distribution and storage losses for the conventional heating system, an electricity consumption of 13.5 kWh/(m² a) results for the radiant heating system and 8.25 kWh/(m² a) for the heat pump heating system with a SPF of 2.

Electric radiant heaters are with regard to the investment a low-cost alternative to conventional heating systems. Based on the life cycle cost, the price of electricity can have an important influence, especially it is subject to seasonal fluctuations, which might be expected with increasing share of renewables in the electricity mix.

The solution for the hot water preparation should be considered in addition for a final comparison.

9. Summary and Conclusions

For a meaningful comparison of the heating demand of different heat emission systems, for the investigated variants the indoor air quality

and the thermal comfort (evaluated according to ISO 7730 with the operating temperature in the living area (generally in the center of the room) and the maximum acceptable radiation temperature asymmetry as well as taking the draught risk into account) must be identical.

In order to compute the differences of a heat emission system, which is predominantly convective or predominantly radiative with sufficient accuracy, a building model with a detailed calculation of the radiation exchange (between each of the surrounding areas, as well as between the surrounding surfaces and a sphere that is used for calculating the operative temperature) is required. With such a model, these effects can be figured out more precisely than with a two-star or star node model, as usually used for building simulations. The assumption of an ideal mixing of air is acceptable in rooms with very good insulation level and mechanical ventilation with heat recovery, however, it does not apply in case of radiative ceiling and/or ventilation without heat recovery. A computational flow simulation (CFD) for determining the temperature stratification would be required additionally for a more accurate analysis.

For the same temporal and spatial thermal comfort, within the model accuracy no significant differences in the heating demand can be obtained between a heat emission which is predominantly convective and one which is predominately radiative.

A numerically or experimentally determined reduction of the heating demand, which results from either a reduction of indoor air quality or of the thermal comfort, cannot be called a reduction in the strict sense (i.e. in the sense of a better efficiency of the heat emission system – in the same way as a reduction of the heating demand by reducing the air exchange cannot be accounted for energy savings, but represents a deterioration of indoor air quality or energy savings through temporary heating or local heating is not energy saving but a temporal or spatial reduction of the thermal comfort).

If comfort is only defined for the occupied space, i.e. traffic area (in the same way as in case of ventilation on demand indoor air quality is defined only during presence i.e. there is no loss of comfort with regard to the temporal and local presence of the user), a low energy saving can be achieved without loss of comfort (i.e. with local

comfort). It must be noted that the potential to create thermal comfort only locally is greater for small (and consequently hot) areas while however, the radiant temperature asymmetry in this case can even exceed the limit defined in ISO 7730.

Careful planning and proper sizing of the radiative heater is essential. A precise temporal and spatial control of the radiant heater is also crucial to achieve good thermal comfort.

A radiant heater as a sole heating system is generally not recommended without heat recovery. A convective heating part is required to preheat the occasionally very cold air in order to avoid cold air drop and cold air stratification.

Not only the heating demand, but the entire production, transport and storage chain must be considered in a comprehensive assessment. In contrast to a central heating system there are no storage and distribution losses in case of an electric radiant heating system. Eventually, the primary energy consumption of the whole building needs to be compared. The technical solution for domestic hot water preparation has to be considered for that, too.

9. Outlook

Especially for deep energy renovation of buildings (e.g. according to the EnerPHit standard [18, 19]) the radiant heating can represent an interesting solution in combination with air heating (e.g. exhaust air HP or split unit) for room-wise control (instead of an electrical re-heating of the air), in particular if there is no (uniform) heat distribution and emission infrastructure.

9 Acknowledgements

IFI Institut für Infrarotwärme GmbH initiated this work. The authors thank IFI Institut für Infrarotwärme GmbH for this initiative and for their support. For part of this work financial support was provided by the Austrian research funding association (FFG) under the scope of “Innovationscheck Plus”.

10. References

[1] J. Kurnitski (Ed.), Cost Optimal and Nearly Zero-Energy Buildings (nZEB) Definitions,

Calculation Principles and Case Studies, Springer (2013)

[2] W. Feist, Passivhaus - die langlebige Lösung, Prof. Dr. Wolfgang Feist, PHI, 20th International Passive House Conference, Darmstadt (2016)

[3] Felder Anton, Untersuchungen zum Coanda-Effekt-mögliche Anwendung im Bauingenieurwesen. Diss., TU München 1993.

[4] EPBD: <https://ec.europa.eu/energy/en/topics/energy-efficiency/buildings> (2012)

[5] ISO 7730:2005, Ergonomics of the thermal environment - Analytical determination and interpretation of thermal comfort using calculation of the PMV and PPD indices and local thermal comfort criteria, 2005

[6] ASHRAE 55: Standard 55-2013 -- Thermal Environmental Conditions for Human Occupancy

[7] Glück Bernd (1994). Zulässige Strahlungstemperatur-Asymmetrie, Gesundheitsingenieur .115. Jg., H. 6. 285 – 293, 1994

[8] http://www.passiv.de/de/01_passivhausinstitut/02_kompetenzbereiche/02_simulation/01_gebaeudesimulation/01_gebaeudesimulation.htm

[9] <https://energyplus.net/>

[10] EN ISO 13790: Energy Performance of Buildings: Calculation of energy Use for Space Heating and Cooling, (2008)

[11] <http://sel.me.wisc.edu/trnsys/>

[12] Crawley, Drury B., Jon W. Hand, Michael Kummert, and Brent T. Griffith, Contrasting the Capabilities of Building Energy Performance Simulation Programs, IBPSA 2005

[13] M. G. Davies, Building Heat Transfer, Wiley (2004)

[14] Awbi, HB and Hatton, A (1999): Natural convection from heated room surfaces, Energy and Buildings, 30,233-244.

[15] Baehr Hans Dieter, Stephan Karl, Wärme- und Stoffübertragung, 7. Auflage, Springer, DOI 10.1007/978-3-642-10194-6, p. 683 ff. (2010)

[16] VDI Heat Atlas, Springer ISBN 9783540778776 • 9783540778769 (2010)

[17] <https://fr.mathworks.com/matlabcentral/fileexchange/5664-view-factors>

[18] Passive House: <http://www.passiv.de>

[19] EnerPHit: http://www.passiv.de/en/03_certification/02_certification_buildings/04_enerphit/04_enerphit.htm