



# Force Calculation I — Introduction

## Force Verification Series Overview

---

This force verification series investigates the accuracy and general numerical behavior of electromagnetic force calculations when using COMSOL Multiphysics® and the AC/DC Module. Employing various techniques, the total force and torque on a rigid body is determined and compared to analytical models. The quality of the computed Maxwell surface stress tensor is investigated.

A great increase in accuracy is achieved by applying fillets, advanced meshing and auxiliary force-probe surfaces. Using the Magnetic Fields, No Currents and Magnetic Fields, No Currents, Boundary Elements interfaces, the *boundary element method* (BEM) and the *finite element method* (FEM) are compared for several mesh sizes. A parametric sweep is used to investigate mesh convergence for both BEM and FEM.

The following tutorials are included in this series:

### FORCE CALCULATION 2 — MAGNETIC FORCE BEM FEM

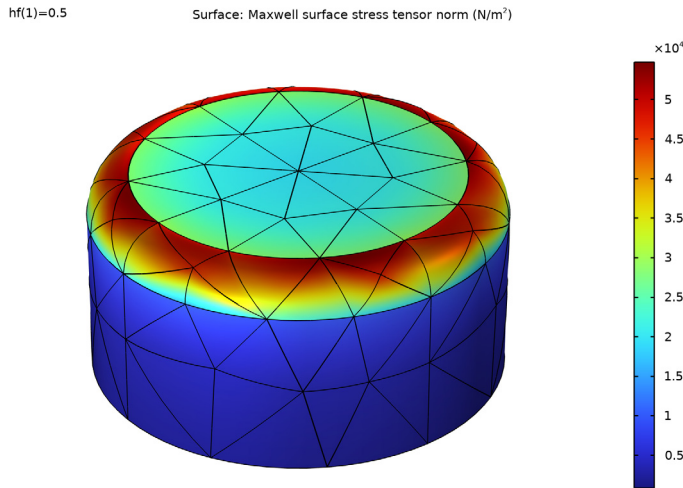

*Figure 1: The Maxwell surface stress tensor at the magnet pole for the force verification case, when using the boundary element method and a mesh scaling factor of one half.*

This verification model treats the case of two parallel magnetized rods of one meter length, placed one meter apart. The relative permeability is assumed to be one everywhere. The remanent flux density  $\mathbf{B}_r$  inside the rods is chosen such that the analytical model predicts a repelling force between the two rods, of one Newton exactly.

### FORCE CALCULATION 3 — MAGNETIC TORQUE BEM FEM

hf(1)=0.5

Surface: Maxwell surface stress tensor norm (N/m<sup>2</sup>)

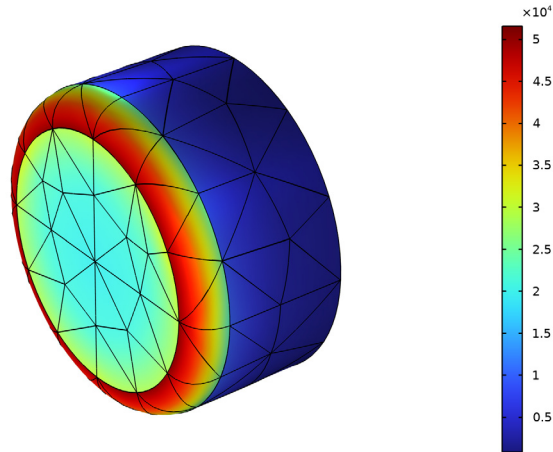

*Figure 2: The Maxwell surface stress tensor at the magnet pole for the torque verification case, when using the boundary element method and a mesh scaling factor of one half.*

This model is a continuation of the *Magnetic Force BEM FEM* verification model. A single magnetized rod of one meter length, is placed in a perpendicular external field  $\mathbf{B}_e$ . The relative permeability is assumed to be one everywhere. The strength of the external field is chosen such that the analytical model predicts a torque on the rod, of one Newton-meter exactly.

## Model Definition (Introduction Tutorial)

---

This model serves as a basis for subsequent tutorials in this series (the *Magnetic Force BEM FEM*, and *Magnetic Torque BEM FEM* tutorials). It provides the geometries used in this series (see [Figure 3](#)), along with detailed modeling instructions for building them (see sections *Modeling Instructions — Magnetic Force Verification Geometry* and *Modeling Instructions — Magnetic Torque Verification Geometry* respectively).

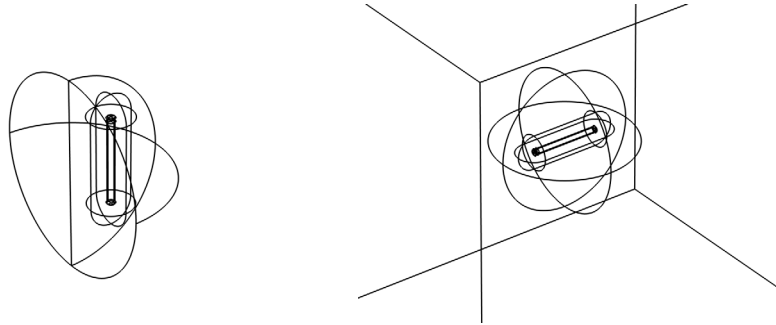

*Figure 3: The geometry used for force verification (left), and torque verification (right).*

The force verification geometry consists of a single rod<sup>1</sup> inside a semisphere. The semisphere will represent the boundary between the Magnetic Fields, No Currents interface, and the Magnetic Fields, No Currents, Boundary Elements interface.

The torque verification geometry consists of a single rod in a spherical domain, encapsulated by a cubic surface. The sphere represents the boundary between the Magnetic Fields, No Currents interface, and the Magnetic Fields, No Currents, Boundary Elements interface. The cube will be used to apply the external field.

Experienced users with little or no interest in geometry building, may choose to skip this part and continue with one of the aforementioned tutorials. When you are new to COMSOL however, or new to this series, it is worthwhile to take some time for this, as it will help you get familiar with the basics.

---

**Application Library path:** ACDC\_Module/Introductory\_Electromagnetic\_Forces/force\_calculation\_01\_introduction

---

---

1. The model itself considers two rods actually; the second rod will be included by means of a symmetry condition in the physics.

## Modeling Instructions (Introduction Tutorial)

---

From the **File** menu, choose **New**.

### NEW

In the **New** window, click  **Model Wizard**.

### MODEL WIZARD

1 In the **Model Wizard** window, click  **3D**.

In this case, we will not select any Physics. This will be done in subsequent tutorials, depending on the analysis performed.

2 Click  **Done**.

### GLOBAL DEFINITIONS

The geometries in this verification series are based on parameters. This is not strictly necessary in COMSOL, rather it accommodates quick adjustments and helps keeping things consistent.

#### Parameters 1

1 In the **Model Builder** window, under **Global Definitions** click **Parameters 1**.

2 In the **Settings** window for **Parameters**, locate the **Parameters** section.

3 Click  **Load from File**.

4 Browse to the model's Application Libraries folder and double-click the file `force_calculation_a_geom_parameters.txt`.

The parameter `Rd` is used to set the distance between a magnetized rod and its mirror image. It is relevant for the *Magnetic Force BEM FEM* verification model. The parameter `Ra` sets the angle at which a single magnetized rod is oriented with respect to a uniform external field, as discussed in the *Magnetic Torque BEM FEM* verification model.

## Modeling Instructions — Magnetic Force Verification Geometry

---

### GEOMETRY 1 (MAGNETIC FORCE VERIFICATION)

1 In the **Model Builder** window, under **Component 1 (comp1)** click **Geometry 1**.

2 In the **Settings** window for **Geometry**, type `Geometry 1 (Magnetic Force Verification)` in the **Label** text field.

The first geometry is used for force verification. Although the model considers two rods, the geometry contains only one of them. The second rod is included later, by means of a symmetry condition in the physics. The rod and its accompanying *force probe surface* are created by means of a revolved work plane.

Start by building the axisymmetric cross section of the rod in the work plane.

*Work Plane 1 (wp1)*

- 1 In the **Geometry** toolbar, click  **Work Plane**.
- 2 In the **Settings** window for **Work Plane**, locate the **Plane Definition** section.
- 3 From the **Plane** list, choose **xz-plane**.

*Work Plane 1 (wp1) > Plane Geometry*

In the **Model Builder** window, click **Plane Geometry**.

*Work Plane 1 (wp1) > Rectangle 1 (r1)*

- 1 In the **Work Plane** toolbar, click  **Rectangle**.
- 2 In the **Settings** window for **Rectangle**, locate the **Size and Shape** section.
- 3 In the **Width** text field, type  $Rr$ .
- 4 In the **Height** text field, type  $Rl$ .
- 5 Locate the **Position** section. In the **yw** text field, type  $-Rl/2$ .
- 6 Click to expand the **Layers** section. In the table, enter the following settings:

Layer name	Thickness (m)
Layer 1	$Rr$

- 7 Clear the **Layers on bottom** checkbox.
- 8 Select the **Layers on top** checkbox.
- 9 In the **Work Plane** toolbar, click  **Build All**.

10 Click the  **Zoom Extents** button in the **Graphics** toolbar.

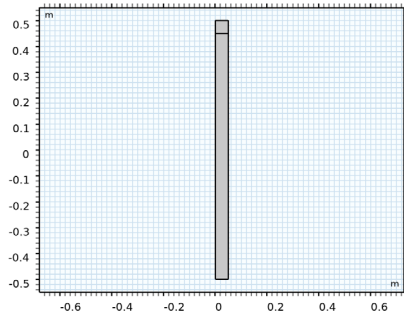

Work Plane 1 (wp1) > Fillet 1 (fil1)

- 1 In the **Work Plane** toolbar, click  **Fillet**.
- 2 In the **Settings** window for **Fillet**, locate the **Radius** section.
- 3 In the **Radius** text field, type  $Rr_f$ .
- 4 On the object **r1**, select Points 4 and 6 only.

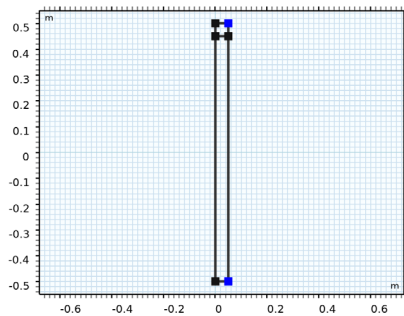

5 In the **Work Plane** toolbar, click  **Build All**.

The fillet is a crucial part of the geometry. Without it the fields will reach a singularity at the sharp corner, making the force calculations less accurate (*feel free to investigate this later*).

Work Plane 1 (wp1) > Rectangle 2 (r2)

- 1 In the **Work Plane** toolbar, click  **Rectangle**.
- 2 In the **Settings** window for **Rectangle**, locate the **Size and Shape** section.
- 3 In the **Width** text field, type  $5 * Rr$ .
- 4 In the **Height** text field, type  $R1 + 10 * Rr$ .
- 5 Locate the **Position** section. In the **yw** text field, type  $-(R1 + 10 * Rr) / 2$ .

6 In the **Work Plane** toolbar, click  **Build All**.

7 Click the  **Zoom Extents** button in the **Graphics** toolbar.

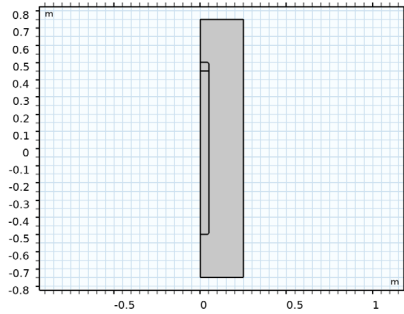

*Work Plane 1 (wp1) > Fillet 2 (fil2)*

1 In the **Work Plane** toolbar, click  **Fillet**.

2 In the **Settings** window for **Fillet**, locate the **Radius** section.

3 In the **Radius** text field, type  $5 * Rr$ .

4 On the object **r2**, select Points 2 and 3 only.

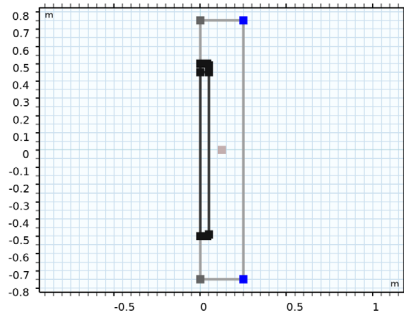

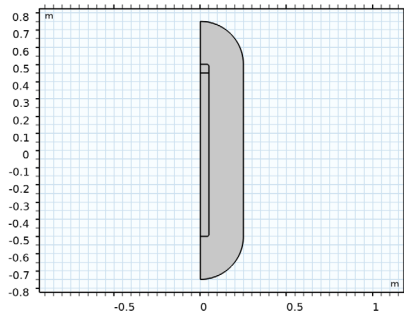

5 In the **Work Plane** toolbar, click  **Build All**.





Now that the axisymmetric cross section is complete, proceed by revolving it into a 3D geometry.

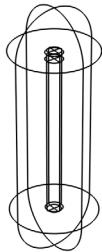

#### Revolve 1 (rev1)

- 1 In the **Model Builder** window, right-click **Geometry 1 (Magnetic Force Verification)** and choose **Revolve**.
- 2 In the **Settings** window for **Revolve**, locate the **Revolution Angles** section.
- 3 Clear the **Keep original faces** checkbox.
- 4 Click  **Build All Objects**.
- 5 Click the  **Wireframe Rendering** button in the **Graphics** toolbar.
- 6 Click the  **Zoom Extents** button in the **Graphics** toolbar.



So far, the geometry has been built around the coordinate system's origin. Since the symmetry plane will be located at  $x = 0$ , the rod will have to be displaced by  $Rd/2$  meters in the positive  $x$  direction. Notice that the parameter  $Rd$  allows you to change the distance between the rods (*feel free to investigate the computed force as a function of  $Rd$  later*).

#### Move 1 (mov1)

- 1 In the **Geometry** toolbar, click  **Transforms** and choose **Move**.
- 2 Select the object **rev1** only.
- 3 In the **Settings** window for **Move**, locate the **Displacement** section.
- 4 In the **x** text field, type  $Rd/2$ .
- 5 Click  **Build All Objects**.

The next work plane is used to build a semisphere. In the *Magnetic Force BEM FEM* verification model, this semisphere will represent the boundary between the **Magnetic Fields, No Currents** interface, and the **Magnetic Fields, No Currents, Boundary Elements 2** interface.

### Work Plane 2 (wp2)

- 1 In the **Geometry** toolbar, click  **Work Plane**.
- 2 In the **Settings** window for **Work Plane**, locate the **Plane Definition** section.
- 3 From the **Plane** list, choose **yz-plane**.



### Work Plane 2 (wp2) > Plane Geometry

In the **Model Builder** window, click **Plane Geometry**.

### Work Plane 2 (wp2) > Circle 1 (c1)

- 1 In the **Work Plane** toolbar, click  **Circle**.
- 2 In the **Settings** window for **Circle**, locate the **Size and Shape** section.
- 3 In the **Radius** text field, type  $1.5 * \sqrt{((Rl/2)^2 + (Rd/2)^2)}$ .

This is actually 1.5 times the distance between one of the rod's poles and the origin.  
Notice that for longer expressions like this one, *the easiest way to go, is to copy-paste them directly from this \*.pdf file to COMSOL*.

- 4 In the **Sector angle** text field, type 180.
- 5 Locate the **Rotation Angle** section. In the **Rotation** text field, type 90.
- 6 In the **Work Plane** toolbar, click  **Build All**.
- 7 Click the  **Zoom Extents** button in the **Graphics** toolbar.

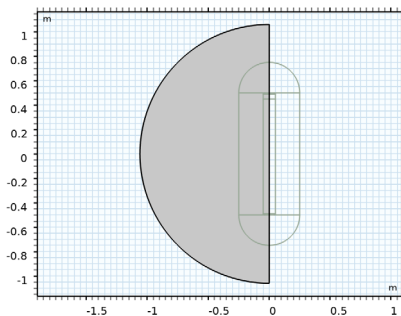

### Revolve 2 (rev2)

- 1 In the **Model Builder** window, right-click **Geometry 1 (Magnetic Force Verification)** and choose **Revolve**.
- 2 In the **Settings** window for **Revolve**, locate the **Revolution Angles** section.
- 3 Click the **Angles** button.
- 4 In the **End angle** text field, type 180.
- 5 Click  **Build All Objects**.

- 6 Click the  **Zoom Extents** button in the **Graphics** toolbar.

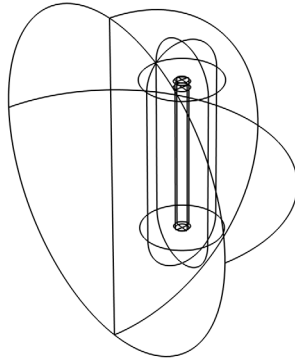

You have now completed the geometry used for the force verification model. You can save the resulting file, so that you can use it as a basis for the second geometry.

- 7 From the **File** menu, choose **Save As**.
- 8 Browse to a suitable folder and type the filename `force_calculation_01_introduction.mph`.

### *Modeling Instructions — Magnetic Torque Verification Geometry*

---

The second geometry is used for torque verification. It contains a single rod in a spherical domain, encapsulated by a cubic surface. The cube will be used to apply an external field. Since the geometry is similar to the one used for force verification, we reuse the sequence from that one and make some modifications.



Start by adding a new model component.

#### **ADD COMPONENT**

In the **Model Builder** window, right-click the root node and choose **Add Component > 3D**.

#### **GEOMETRY 2 (MAGNETIC TORQUE VERIFICATION)**

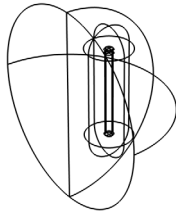

- 1 In the **Settings** window for **Geometry**, type `Geometry 2 (Magnetic Torque Verification)` in the **Label** text field.

- 2 In the **Geometry** toolbar, click **Insert Sequence**.
- 3 Browse to your working folder and double-click the file you have just saved, `force_calculation_01_introduction.mph`.
- 4 In the **Geometry** toolbar, click  **Build All**.
- 5 Click the  **Wireframe Rendering** button in the **Graphics** toolbar.
- 6 Click the  **Zoom Extents** button in the **Graphics** toolbar.



This effectively copies the geometry sequence from **Component 1**, to **Component 2**.  
Next, delete those parts of the sequence that are related to the force verification geometry in particular.

*Revolve 2 (rev2), Work Plane 2 (wp2), Move 1 (mov1)*

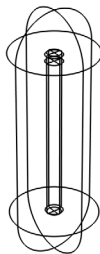

- 1 In the **Model Builder** window, right-click **Revolve 2 (rev2)** and choose **Delete**.
- 2 Repeat these steps for **Work Plane 2 (wp2)**, and **Move 1 (mov1)**.
- 3 In the **Geometry** toolbar, click  **Build All**.
- 4 Click the  **Zoom Extents** button in the **Graphics** toolbar.



The resulting geometry has been built with the rod oriented vertically. Since the external field will be pointing in the  $z$  direction, the rod will have to be rotated by  $R_a$  degrees.

Notice that the parameter **Ra** allows you to change the angle of the rod with respect to the external field (*feel free to investigate the computed torque as a function of Ra later*).

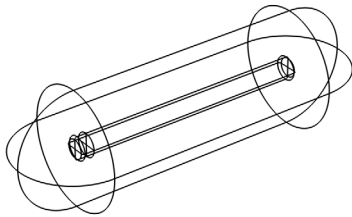

#### *Rotate 1 (rot1)*

- 1 In the **Geometry** toolbar, click  **Transforms** and choose **Rotate**.
- 2 Select the object **rev1** only.
- 3 In the **Settings** window for **Rotate**, locate the **Rotation** section.
- 4 In the **Angle** text field, type Ra.
- 5 From the **Axis type** list, choose **y-axis**.
- 6 Click  **Build All Objects**.
- 7 Click the  **Zoom Extents** button in the **Graphics** toolbar.



Next will be a spherical domain and a cubic surface. In the *Magnetic Torque BEM FEM* verification model, the sphere will represent the boundary between the **Magnetic Fields, No Currents** interface, and the **Magnetic Fields, No Currents, Boundary Elements 2** interface.



#### *Sphere 1 (sph1)*

- 1 In the **Geometry** toolbar, click  **Sphere**.
- 2 In the **Settings** window for **Sphere**, locate the **Size** section.
- 3 In the **Radius** text field, type R1.
- 4 Click  **Build All Objects**.

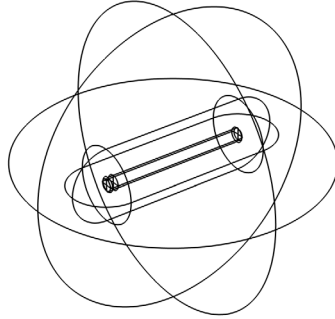
- 5 Click the  **Zoom Extents** button in the **Graphics** toolbar.



*Block 1 (blk1)*

- 1 In the **Geometry** toolbar, click  **Block**.
- 2 In the **Settings** window for **Block**, locate the **Object Type** section.
- 3 From the **Type** list, choose **Surface** (*this setting is important for the model to work properly, its implications will become apparent in subsequent tutorials*).
- 4 Locate the **Size and Shape** section. In the **Width** text field, type Cs.
- 5 In the **Depth** text field, type Cs.
- 6 In the **Height** text field, type Cs.
- 7 Locate the **Position** section. From the **Base** list, choose **Center**.
- 8 Click  **Build All Objects**.

9 Click the  **Zoom Extents** button in the **Graphics** toolbar.

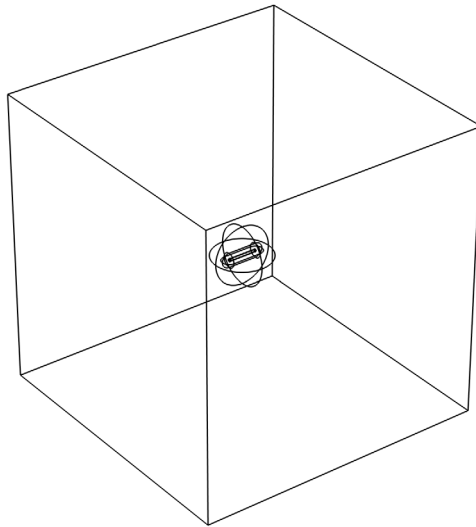

You have now completed the geometry used for the torque verification model. The result is a COMSOL file containing two geometries. These will serve as a basis for several models investigating the accuracy of force and torque computations for different methods and formulations. Subsequent tutorials will refer to this file, as `force_calculation_01_introduction.mph`.

The next tutorial in this series will investigate the performance of the *boundary element method* (BEM) and the *finite element method* (FEM) within the context of force calculations.

