



COMSOL
CONFERENCE
2014 CAMBRIDGE

R. Haettel, M. Kavasoglu, A. Daneryd and C. Ploetner, ABB, 2014-09-18

Prediction of Transformer Core Noise Multiphysics Approach

Presentation Outline

- Introduction and Background
- Transformer Acoustics
- Model development for Core Noise
 - Electromagnetic Model
 - Magnetostriction Implementation
 - Mechanical and Acoustic Models
 - Model Validation
- Conclusion

Product and System Examples



Multiphysics Approach

- The sound generation in ABB products requires a global understanding of the energy conversion chain from electrical input to noise
- Strong interaction among the technical fields is required
- Multiphysics Approach implies strong cooperation
- Noise level is an essential parameter to assess a product quality

Energy Conversion Chain from electric supply to noise

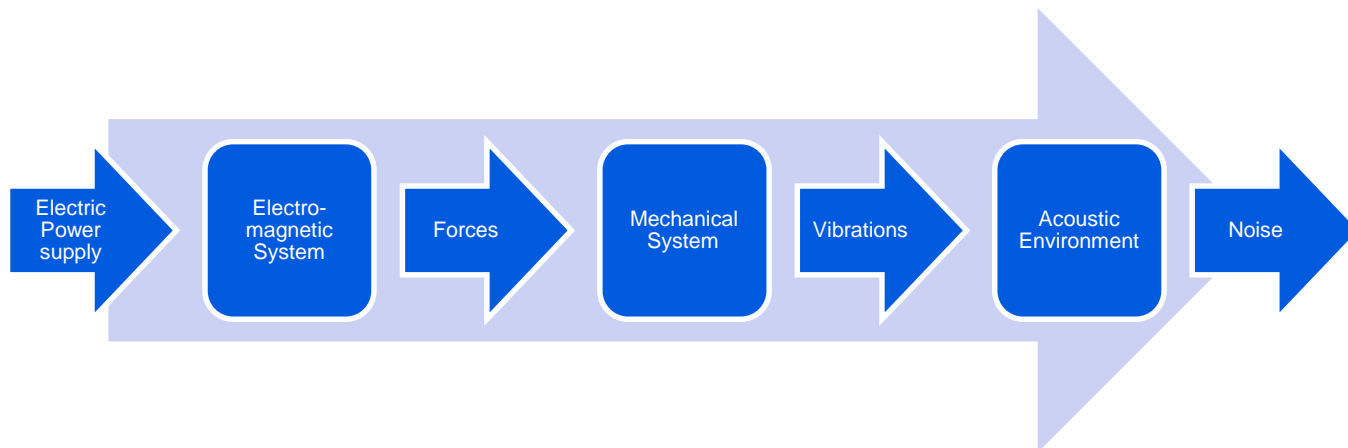

Project Drivers

- Costs for noise issues such as orders lost, costly modifications and overkill margins in design
- Significant advances by major competitors in noise mitigation
- Increased focus on environmental issues (customer requirements)
- Product development: Tools to investigate the impact of present and future requirements and design

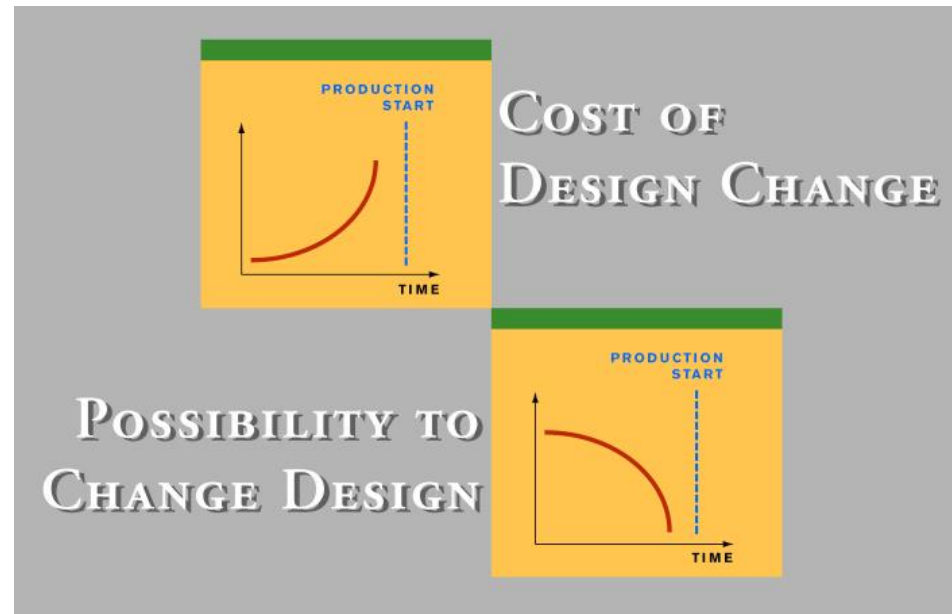

Power Transformers

- Power Transformers enable electricity production, transport and distribution at the most convenient (economical) voltages
- They can be considered as the “gearboxes” of the electrical grid
- A power transformer is a component that receives power at one voltage and delivers virtually the same power at another voltage

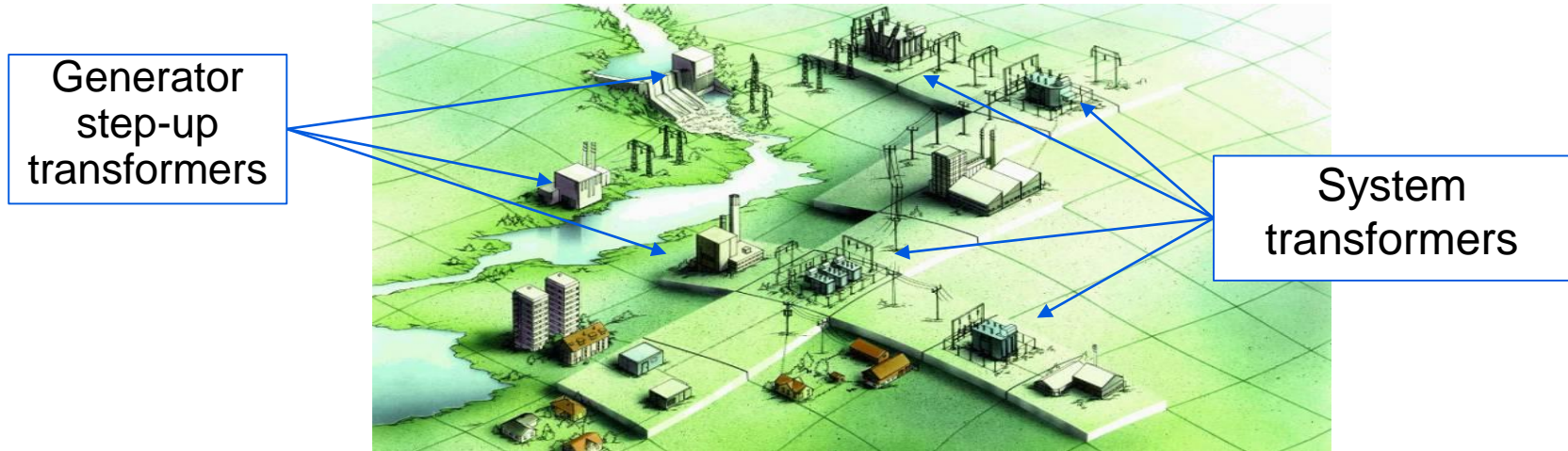

Main Components in Power Transformers

- Power transformers have a core to handle the magnetic flux
- They have windings to lead the currents and to provide the correct voltage
- The core, windings, insulation material and mechanical frame constitute the active part

ACTIVE PART

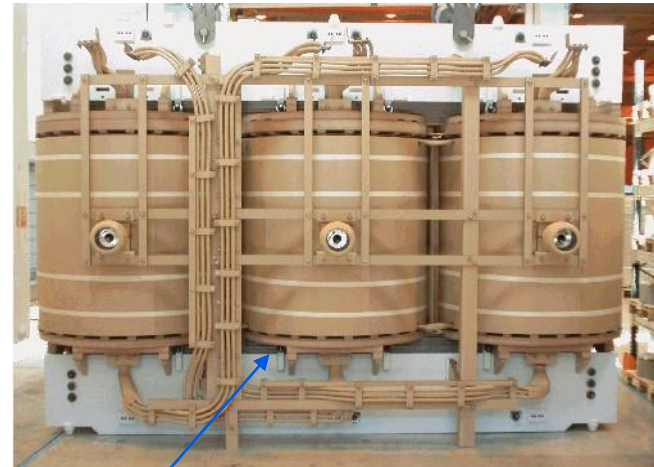
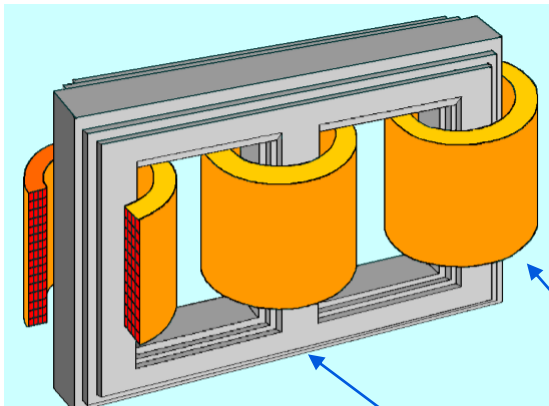

Core

Windings

Transformer Acoustics

- No-load noise (core noise)
 - Load noise (winding noise)
-
- Now: empirical models based on statistics and use of fitting coefficients
 - Next stage: detailed analysis and models of:
 - Core in air and oil
 - Winding in air and oil
 - Tank and oil interactions
 - Structural transmission paths
 - Synthesis phase in the modeling chain: Development of a 3D-model for the whole system
 - Experimental validation

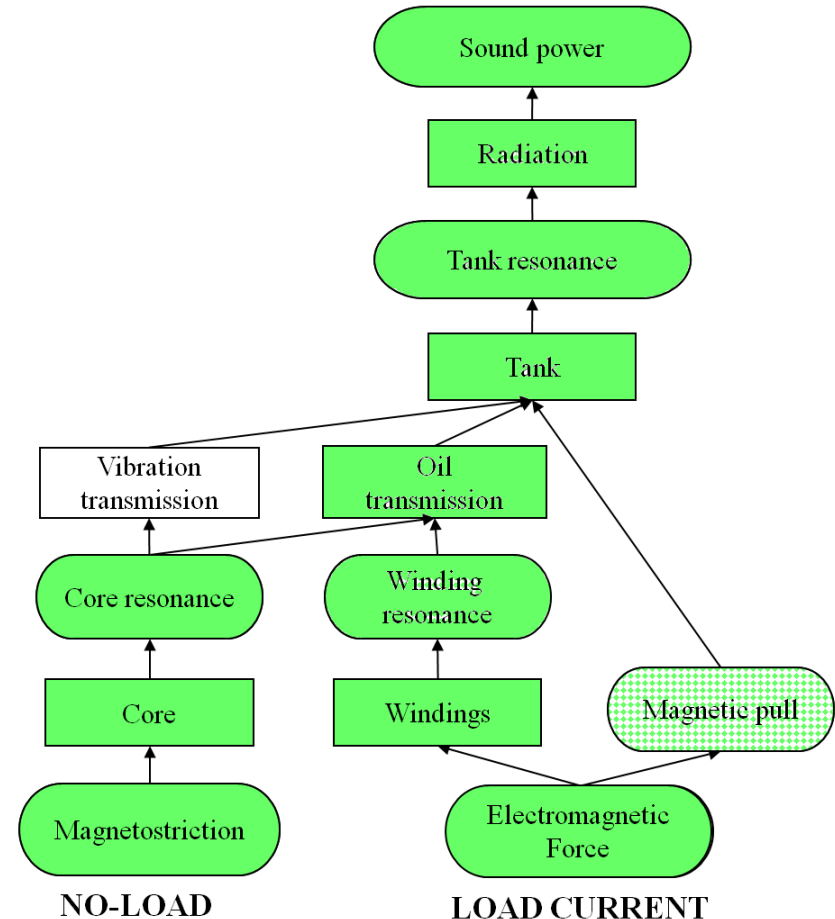

Transformer Core Noise

- The spectrum of core noise is characterized in AC conditions by a fundamental tone at 100 Hz (120 Hz) and several harmonics at $n \times 100$ Hz ($n \times 120$ Hz) with $n = 2, 3, \dots$
- Noise is generated by magnetostriction in core laminations

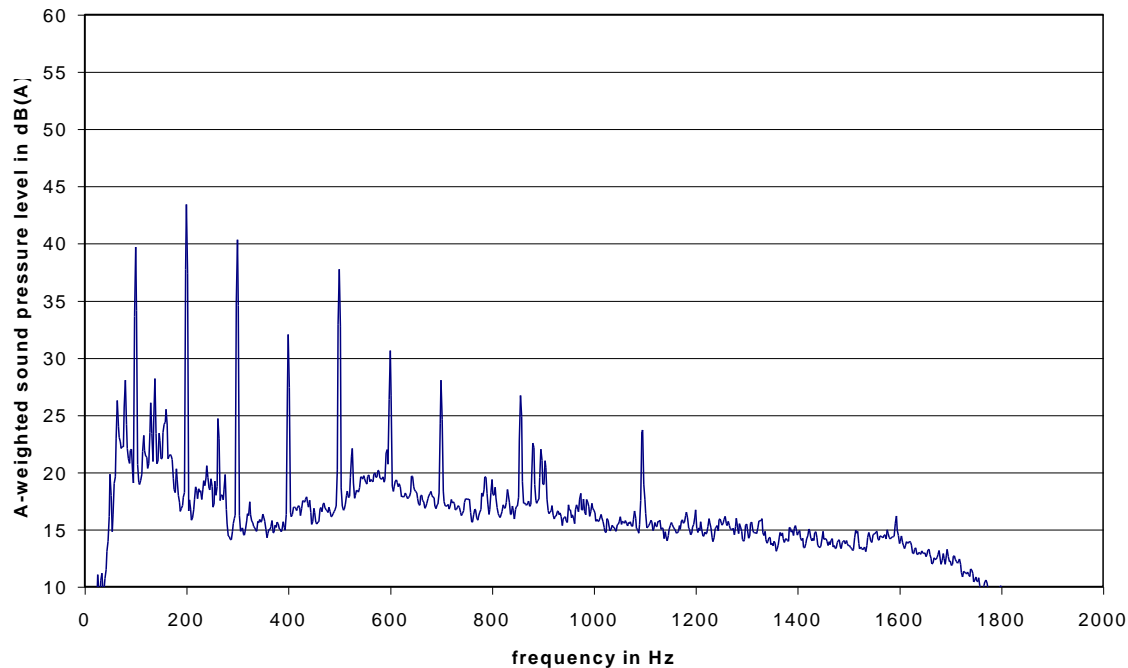

Behind the Standard Measurements

General model for sound transmission

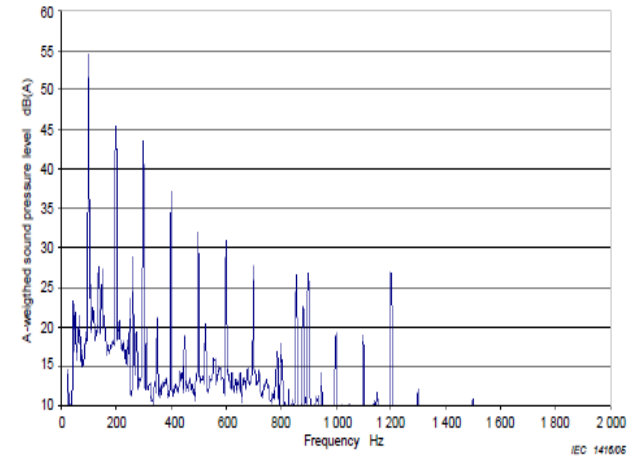
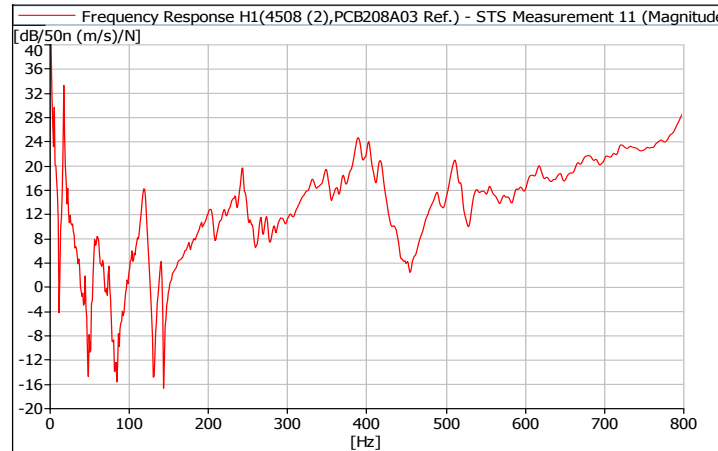
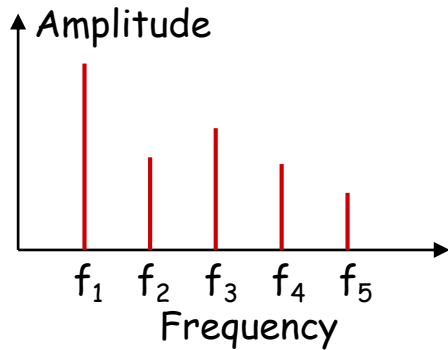

FRF: Frequency Response Function

Core Noise Prediction: Coredyn 2.0

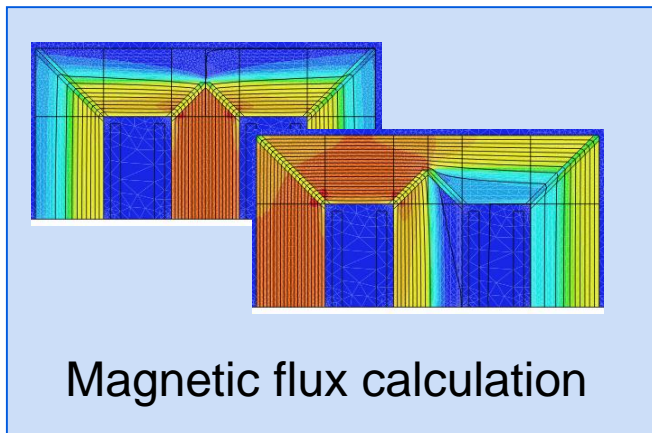
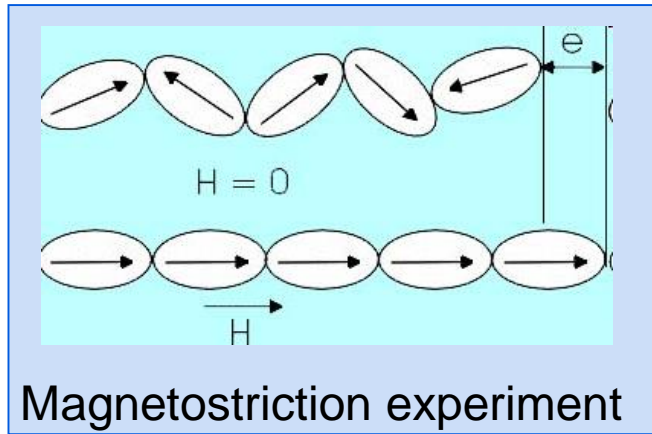

$\lambda = \lambda(B, f, \varphi_\lambda)$

$B = B(x, y, f, \varphi_B)$

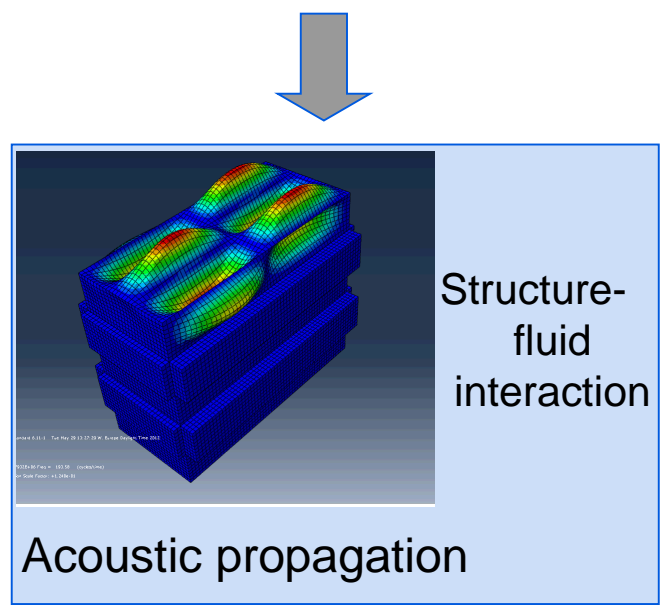
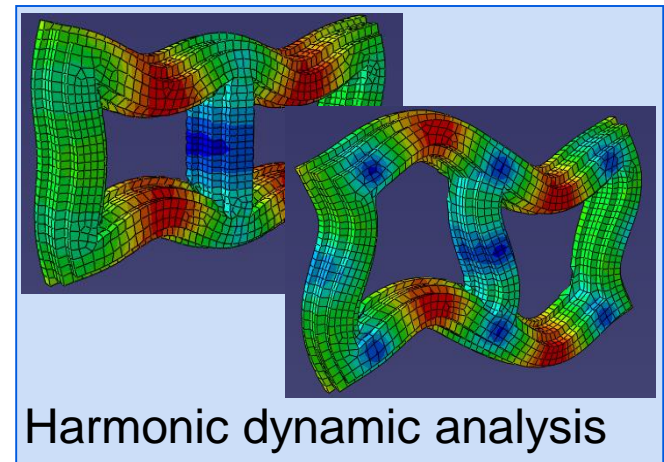

Model Development

The complete chain for prediction can be expressed from Magnetic Flux Density to Acoustic Power:

$$U \rightarrow B \rightarrow \lambda(rd, crd) \rightarrow \varepsilon(x, y) \rightarrow F \rightarrow v_{core} \rightarrow p_{oil} \rightarrow v_{tank} \rightarrow p_{tank} \rightarrow W$$

Magnetostriction data can be regarded as the essential input

The Total Acoustic Power can be written in the matrix form with the harmonics contribution:

$$W = \sum_i \Lambda_i^H \hat{B}_i \Lambda_i$$

Electromagnetic Model

- At no-load conditions, a voltage is applied to the windings on one side of the transformer while the windings on the other side are left open
- The magnetic flux density induced in the core $\mathbf{B} = \mu\mathbf{H}$ with μ magnetic permeability in the core material and \mathbf{H} the magnetic field strength
- The current density $\mathbf{J} = \sigma\mathbf{E}$ with σ conductivity and \mathbf{E} the electric field density
- The resulting magnetic flux density $\mathbf{B} = \nabla \times \mathbf{A}$ induced by the total currents (Ampere turns) with \mathbf{A} the magnetic vector potential
- The governing equation for the magnetic field is given by the relationship
$$\sigma \frac{\partial \mathbf{A}}{\partial t} + \nabla \times \left(\frac{\nabla \times \mathbf{A}}{\mu} \right) = \mathbf{J}$$
- The model is investigated in two dimensions by considering one single core package at a time
- The magnetically insulating boundary condition on the outer boundary imposing the constraint $\mathbf{n} \cdot \mathbf{H} = 0$ with the normal component of the magnetic field set to zero

Magnetic Flux Density Prediction

- Experimental data for a specific steel type are used in the model to describe the magnetic properties of the core material. The core steel sheets are magnetically oriented and the permeabilities in the rolling and cross-rolling directions present different non-linear virgin curves
- The excitation is provided by voltages shifted by a phase of 120° applied to the windings to simulate a three phase transformer
- The analysis is carried out in the time domain to obtain a magnetic field density in the core

Magnetic flux density Distribution

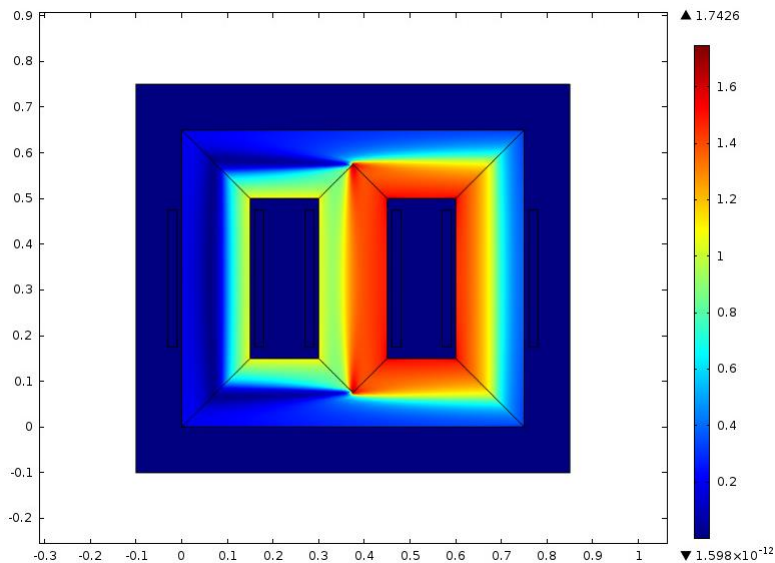

Magnetic flux density at Middle Limbs

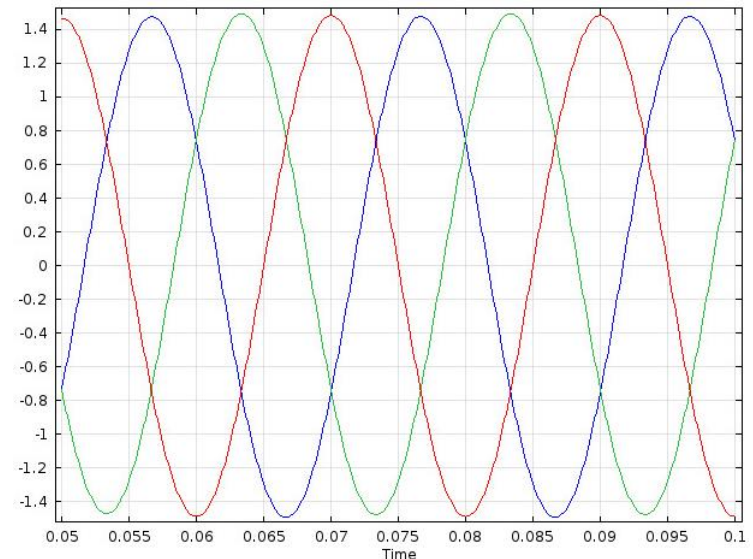

Magnetostriction Implementation

- The main frequency components of the magnetic flux density are obtained by applying a FFT on the time signals in rolling and cross-rolling directions
- The fundamental magnetic components at each node can be associated with magnetostrictive strains available in tables gathering experimental data specific for each steel grade

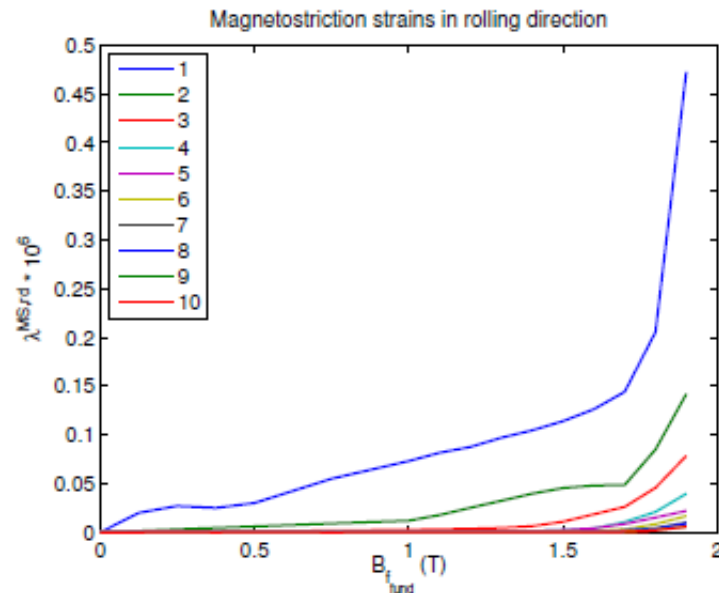

Mechanical Model

- The linear elasticity equations are used to describe the in-plane motion of the core
- The electric steel has different properties in rolling and cross-rolling directions
- The elasticity tensor is specified for an orthotropic material
- The governing equation for the core motion

$$M\ddot{u}^N + C\dot{u}^N + Ku^N = f^N$$

- The excitation due to the magnetostrictive strains

$$f^N = \int B^T E \varepsilon^{mag} dV$$

Core Motion

Overall in-plane displacement of the core for a frequency sweep

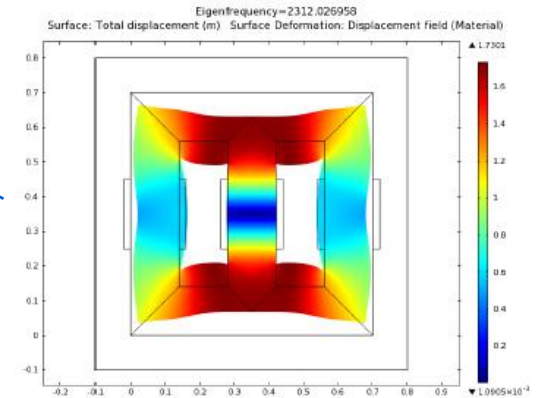
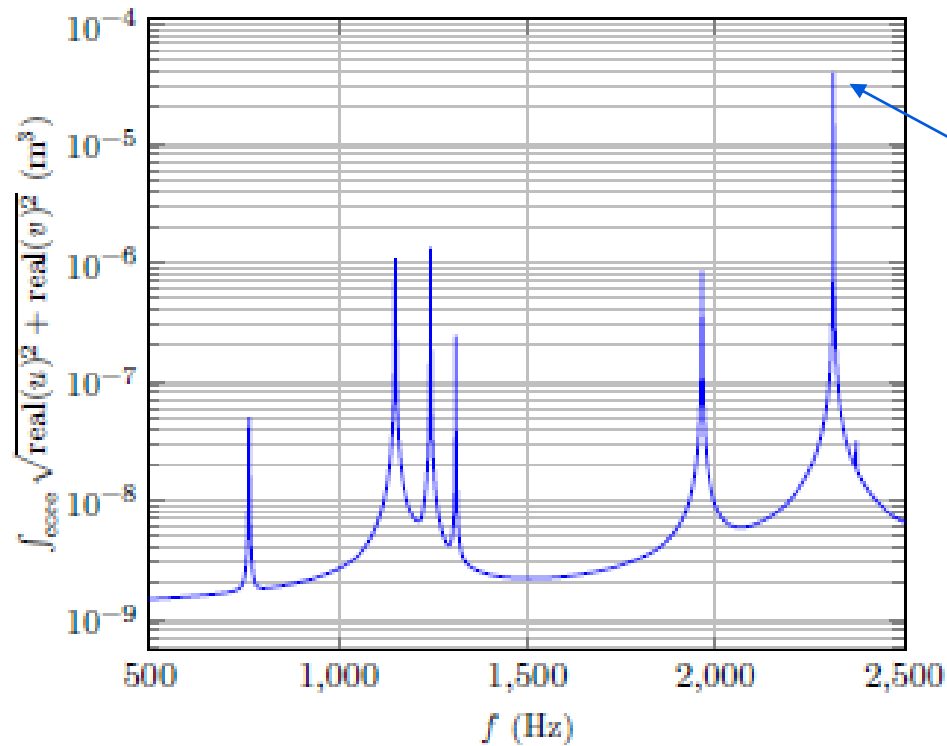

Core resonance at 2312 Hz

Acoustics Model

- The core motion generates sound waves in the surrounding media

$$\nabla^2 p - \frac{1}{c^2} \frac{\partial^2 p}{\partial t^2} = 0$$

- The relationship between pressure and velocity is obtained by using the linear equation of motion

$$\rho \frac{\partial \mathbf{u}}{\partial t} = -\nabla p$$

- The acoustic analysis is performed in 3D by extruding the 2D model used for the mechanical simulations
- Perfectly Matched Layers (PML) are used to create a free space for sound propagation

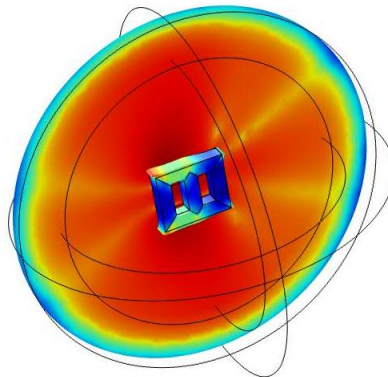

Validation on Test Core

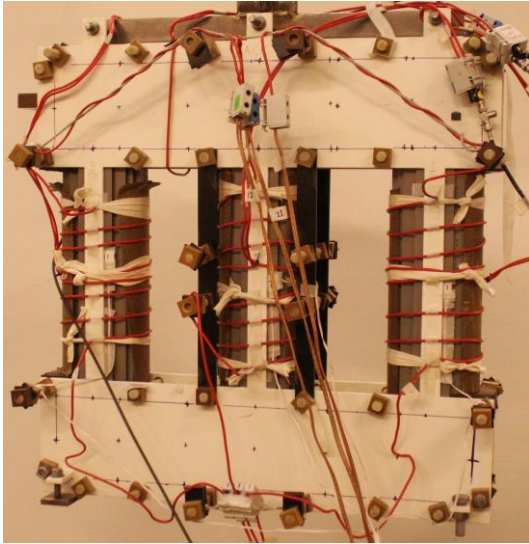

Core Height	700 mm
Core Length	700 mm
Limb Pitch	280 mm
Limb Diameter	140 mm
Core Steel Type	0,23 mm Grain-Oriented

Resonance at 763 Hz

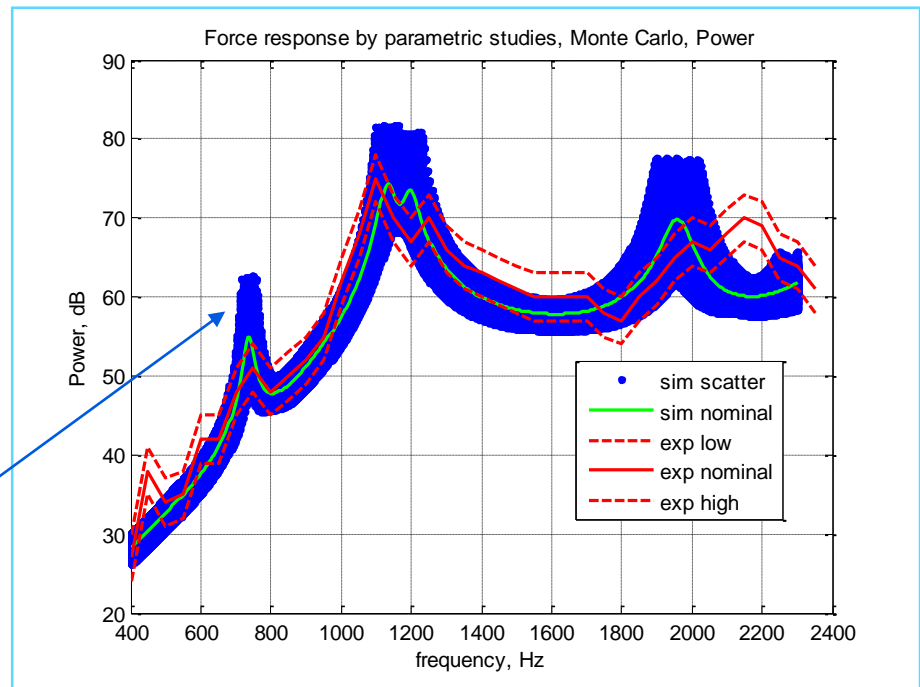
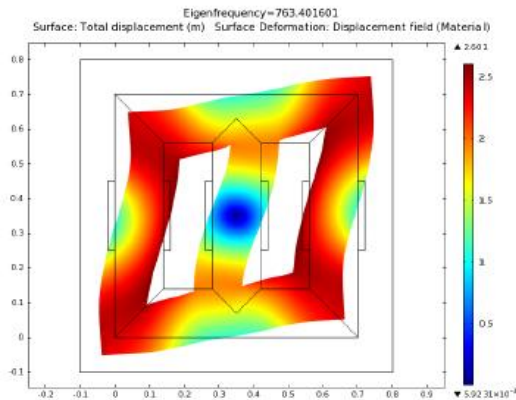

Conclusion

- A multiphysic model to predict transformer core noise was built in COMSOL
- The electromagnetic model of the core in 2D is solved in time domain
- The resulting magnetostrictive forces are used in the frequency domain to perform the mechanical and acoustic analysis in 3D
- Future work on oil-immersed core and implementation of BEM for sound propagation

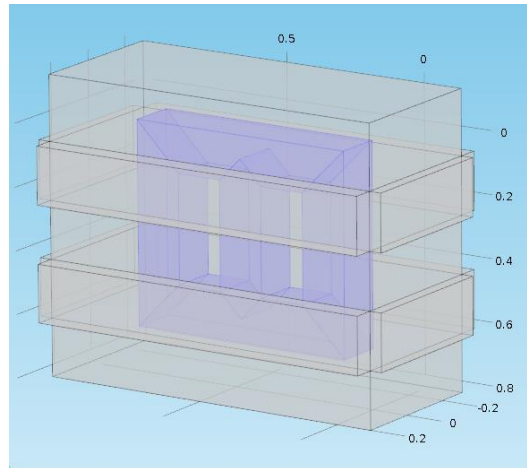

Power and productivity
for a better world™

