

Research for Sustainable Technologies



**DECHEMA**  
FORSCHUNGSINSTITUT  
Stiftung bürgerlichen Rechts

*J.-F. Drillet*

# DMFC Model with COMSOL

Comsol conference, Munich, 12.10.2016

**COMSOL**  
**CONFERENCE**  
2016 MUNICH

**Materials**  
**Chemical Engineering**  
**Biotechnology**

# State-of-the art and challenges of Direct Methanol Fuel Cell

## Commercial available DMFC for off-grid

**applications** : The Company, owner of the globally established EFOY COMFORT and EFOY Pro fuel cell generator brands, has sold over **35,000** of its systems into a large number of industrial, defense and consumer applications:  
<http://www.sfc.com/en/markets/overview>

**EFOY Pro 12000 Duo (SFC AG, Brunenthal)**

**24 V / 20,8 A**

48 V / 10.4 A

Max. nominal power **500 W**

640 x 441 x 310 mm = **87,5 l**

Weight: **33 kg**

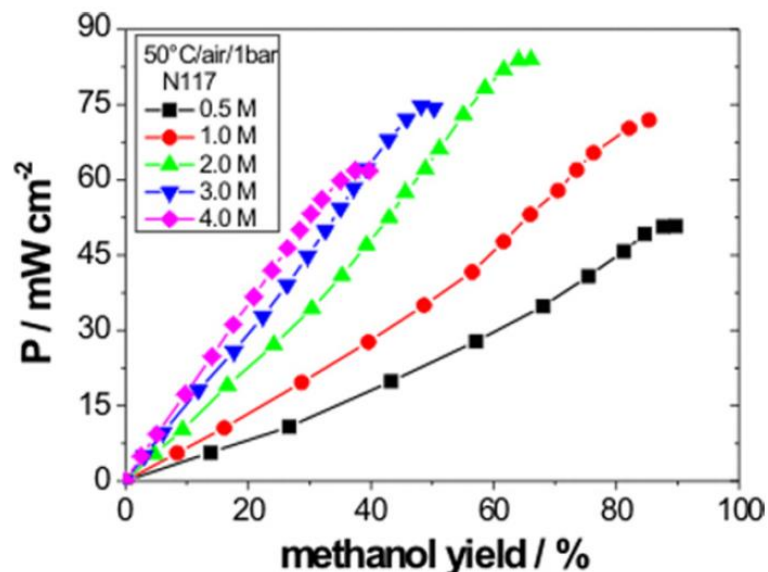

## Main challenges to overcome:

- Increase of both power density and methanol yield!
- Limitation of methanol cross-over through PEM membrane
- reduce Catalyst loading

# Principle of Direct Methanol Fuel Cell

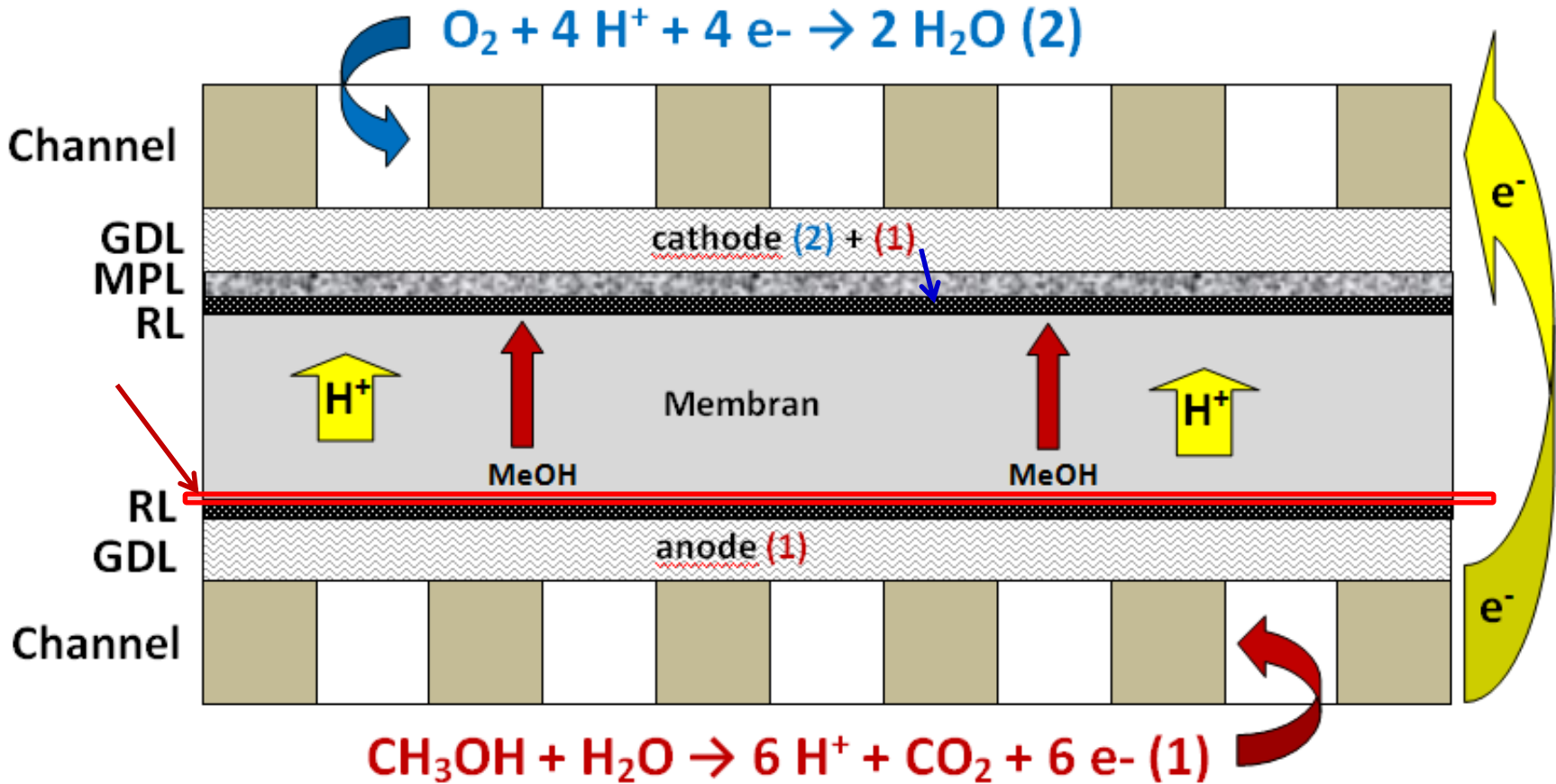

➤ Optimal case:  $C_{MeOH}$  at  $RL_a$ /membrane interface = 0

# Domains and physics

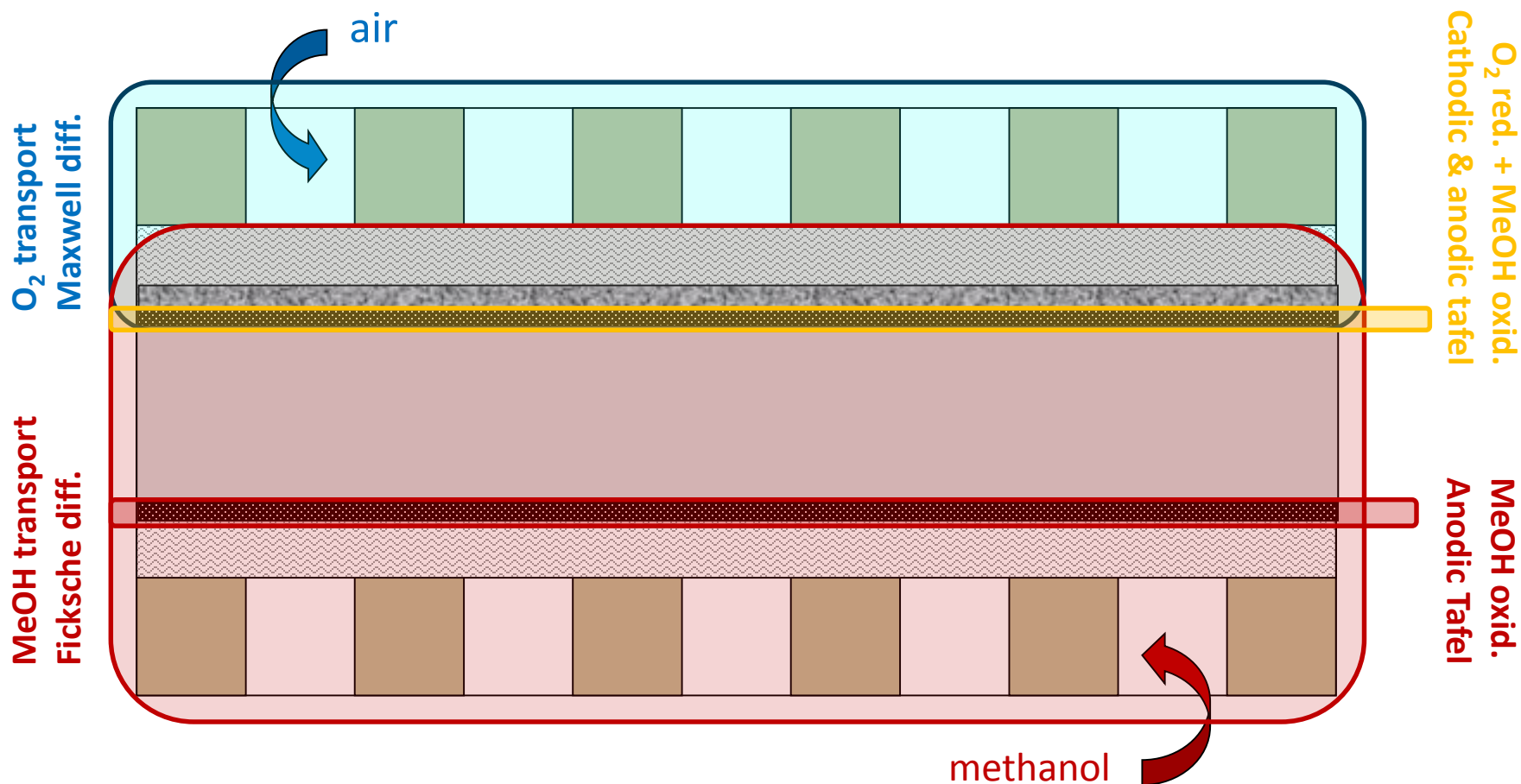

- Assumptions: - no transport of molecular O<sub>2</sub> through Nafion membrane
- no methanol transport from RL cathode to channel cathode

Electronic/Ionic charge balance	Ohm's law	$I = \sigma \Delta \cdot V$
Charge transfer kinetics for $\eta \ll$	Butler-Volmer	$i_a = i_0 * \left(\frac{c_{meoh}}{c_{meoh,ref}}\right) \exp\left(\frac{\alpha_{a,a}}{R * T} F * \eta_a\right)$ with $i_0 = F k_0 c_{ox}^\alpha c_{red}^{(1-\alpha)}$
Charge transfer kinetics for $\eta \gg$	Tafel	$i_{loc} = i_0 10^{\eta/A\alpha}, i_{loc} = -i_0 10^{\eta/Ac}$
Concentration dependency of $i_0$		$i_0 = i_{0\_MORa} * (rfcs.c\_wMeOH_a / c_{MeOH.ref})$
Charge transport in electrolyte	Nernst-Planck	$N_i = -D_i \nabla c_i - z_i u_i F c_i \nabla \Phi + c_i u$
Coupled mass transport in free channel and porous electrode	Navier-Stokes	$\rho \frac{\partial u}{\partial t} + \nabla \cdot [-\eta(\nabla u + \nabla u^T) + pI] = -\rho(u \cdot \nabla)u$
	Brinkman	$\frac{\rho}{\varepsilon_p} \frac{\partial u}{\partial t} + \nabla \cdot \left[-\eta \frac{\eta}{\varepsilon_p} (\nabla u + \nabla u^T) + pI\right] = -\frac{\eta}{k} u$
Mass balances in gas phase in gas channels and porous electrodes	Fick	$-\nabla \cdot (-D \cdot \nabla c + c \cdot u) = 0$
	Maxwell-Stefan	$-\nabla \cdot \left[-\rho \omega_i \sum_{j=1}^N D_{ij} \left\{ \frac{M}{M_j} (\nabla \omega_j + \omega_j \frac{\nabla M}{M}) + \left(x_j - \omega_j \frac{\nabla p}{p}\right) \right\} + \omega_i \rho u\right] = 0$

$A_o =$  anodic Tafel slope (V decade<sup>-1</sup>)  
 $c =$  concentration (mol m<sup>-3</sup>)  
 $D =$  diffusion coefficient (m<sup>2</sup> s<sup>-1</sup>)  
 $F =$  Faraday constant (C mol<sup>-1</sup>)  
 $i_a =$  anodic current density (A m<sup>-2</sup>)  
 $i_0 =$  exchange current density (A m<sup>-2</sup>)  
 $I =$  current (A)  
 $N_i =$  charge transport in electrolyte (mol m<sup>-2</sup> s<sup>-1</sup>)  
 $p =$  pressure (Pa)  
 $u =$  velocity (m s<sup>-1</sup>)  
 $V =$  potential (V)  
 $z =$  number of electron (-)  
 $\alpha =$  symetrie factor (-)  
 $\eta =$  dynamic viscosity (Pa · s)  
 $\eta_a =$  anodic overpotential (V)  
 $\varepsilon_p =$  porosity (-)  
 $\kappa =$  permeability (m<sup>2</sup>)  
 $\Phi =$  potential in electrolyte (V)  
 $\rho =$  density (kg m<sup>-3</sup>)  
 $\sigma =$  conductivity (S m<sup>-1</sup>)  
 $II =$  Tensor

# Geometry

➤ **WP8 + extrude** opposite direction:  $H_{ch} + H_{GDLc} + H_{MPLc} + H_{RLc} + H_M + H_{Rla} + H_{GDLa}$

➤ **WP8**: channel cathode

➤ **WP7 + extrude**: GDL cathode

➤ **WP6 + extrude**: MPL cathode

➤ **WP5 + extrude**: RL cathode

➤ **WP4 + extrude**: Membrane

➤ **WP3 + extrude**: RL anode

➤ **WP2 + extrude**: GDL anode

➤ **WP1 + extrude**:  $H_{ch} + H_{GDLa} + H_{Rla} + H_M + H_{RLc} + H_{GDLc} + H_{MPLc}$

➤ **WP1**: channel anode

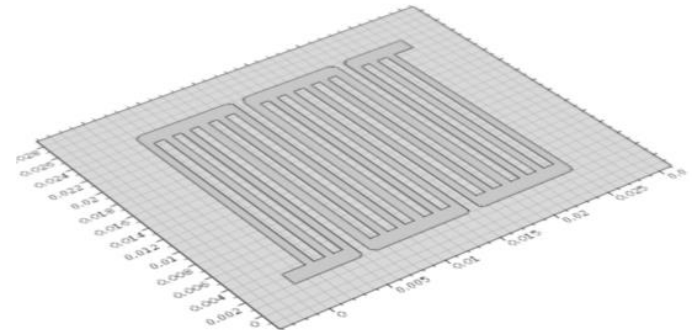
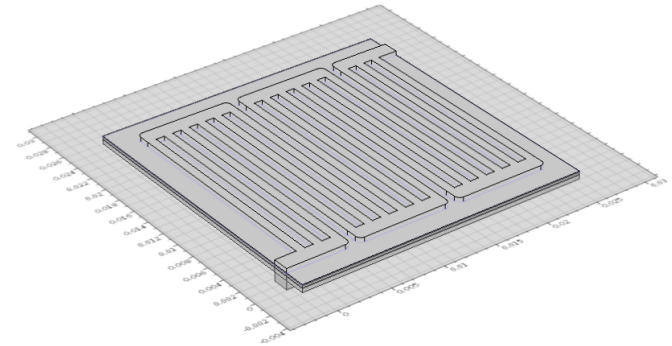
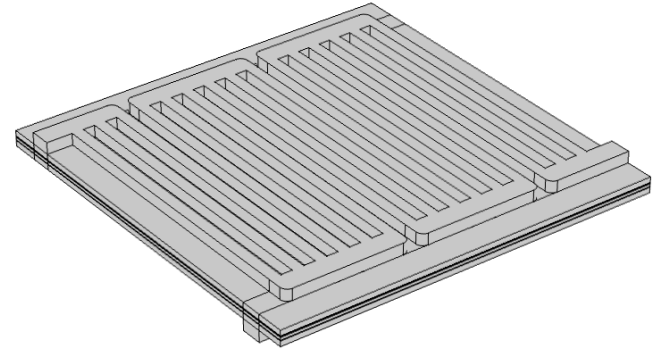



# Mesh

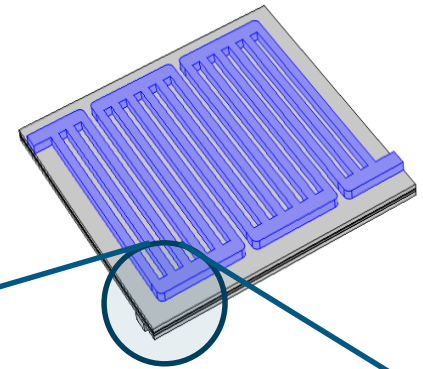

- ❖ **Size:** fine
- ❖ **Free Triangular**
- ❖ **Swept:** generates **hexahedrons**
  - **Distribution:** **3** elements
- ❖ **Complete mesh** consists of
  - **253020** domain elements
  - **172658** boundary elements
  - **32654** edge elements.

- Air Channel cathode
- Gas Diffusion Layer GDLc
- Micro Porous layer MPLc
  - Reaction Layer RLC
  - Membrane
  - Reaction Layer RLc
- Gas diffusion Layer GDLa
- MeOH Channel inlet

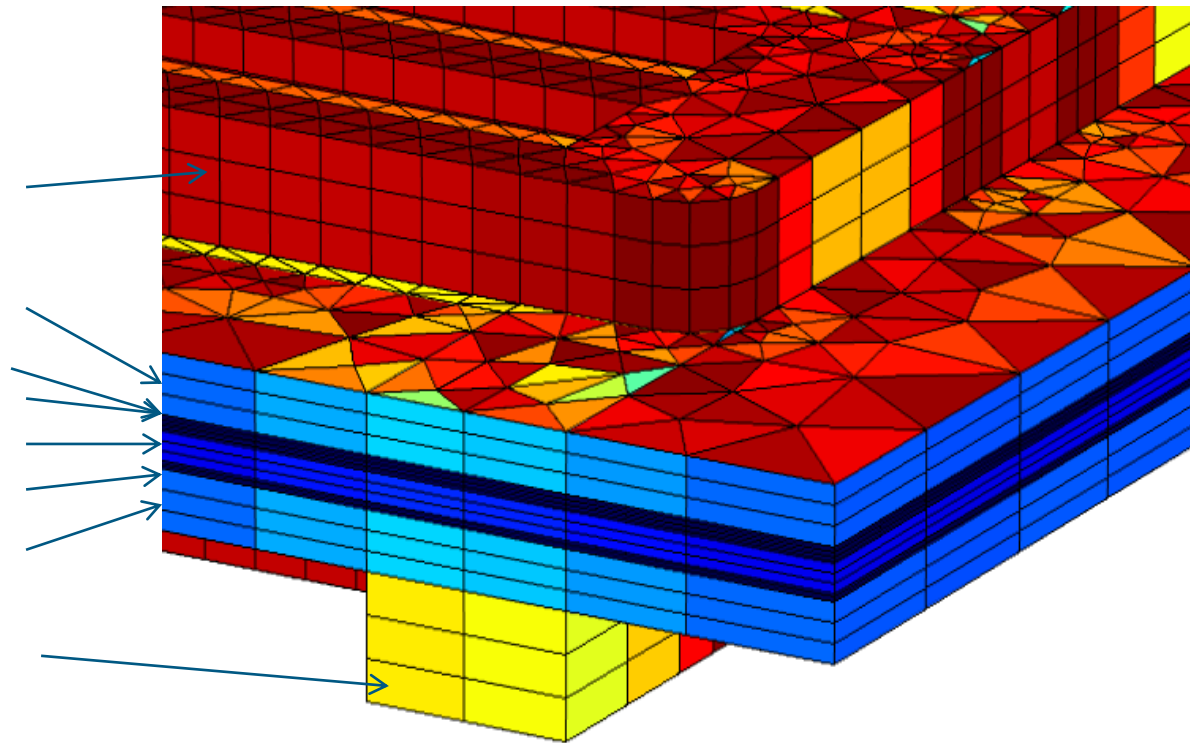

# U-I characteristic in function of practical reaction equilibriums $E_0$

	$V_{\text{cell}}$ V	$w_{\text{O}_2, \text{in}}$ wt%	$E_{0, \text{MORa}}$ V	$E_{0, \text{MORc}}$ V	$E_{0, \text{ORRc}}$ V	$I_{\text{max}}$ A cm <sup>-2</sup>
04.07.2016	0.8	0.9	0.45	0.6	1	0.39
12.07.2016	0.8	0.9	0.35	0.6	1.1	1.85
10.08.2016	0.8	0.9	0.35	0.6	1.23	div
16.08.2016	0.8	0.9	0.35	0.6	1.2	1.75
22.08.2016	0.8	0.9	0.25	0.6	1.2	3.3
05.09.2016	0.8	0.9	0.3	0.55	1.2	div.
07.09.2016	0.8	0.9	0.25	0.55	1.2	div.
12.09.2016	0.8	0.9	0.35	0.6	1.15	1.85
19.09.2016	0.8	0.9	0.35	0.55	1.1	1.2
23.09.2016	0.8	0.2	0.35	0.55	1.1	0.015
29.09.2016	0.8	0.2	0.35	0.55	1.15	div.
04.10.2016	0.8	0.2	0.35	0.6	1.15	0.040

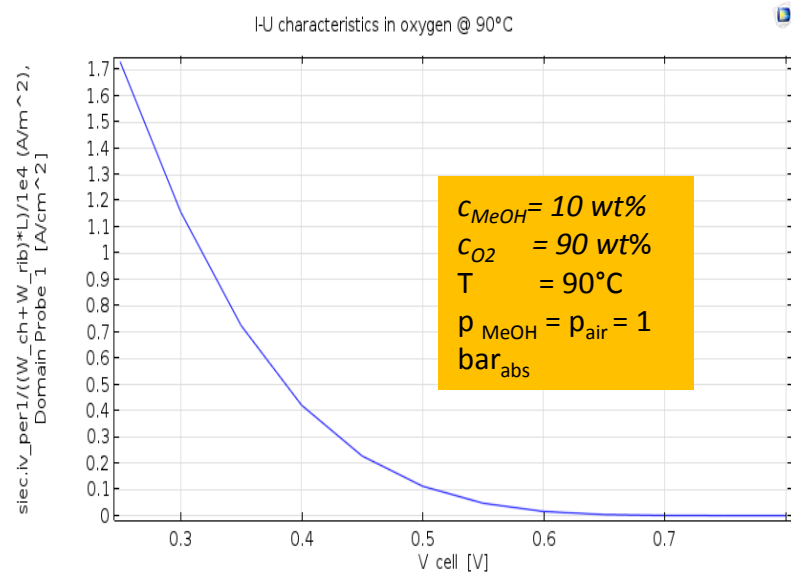

➤ Fuel cell performance is strongly dependent on experimentally parameters such as  $E_0$ , exchange current density  $i_0$ , Tafel slope  $b$



# MeOH/air velocity and pressure profiles in channels @ 0,25 V

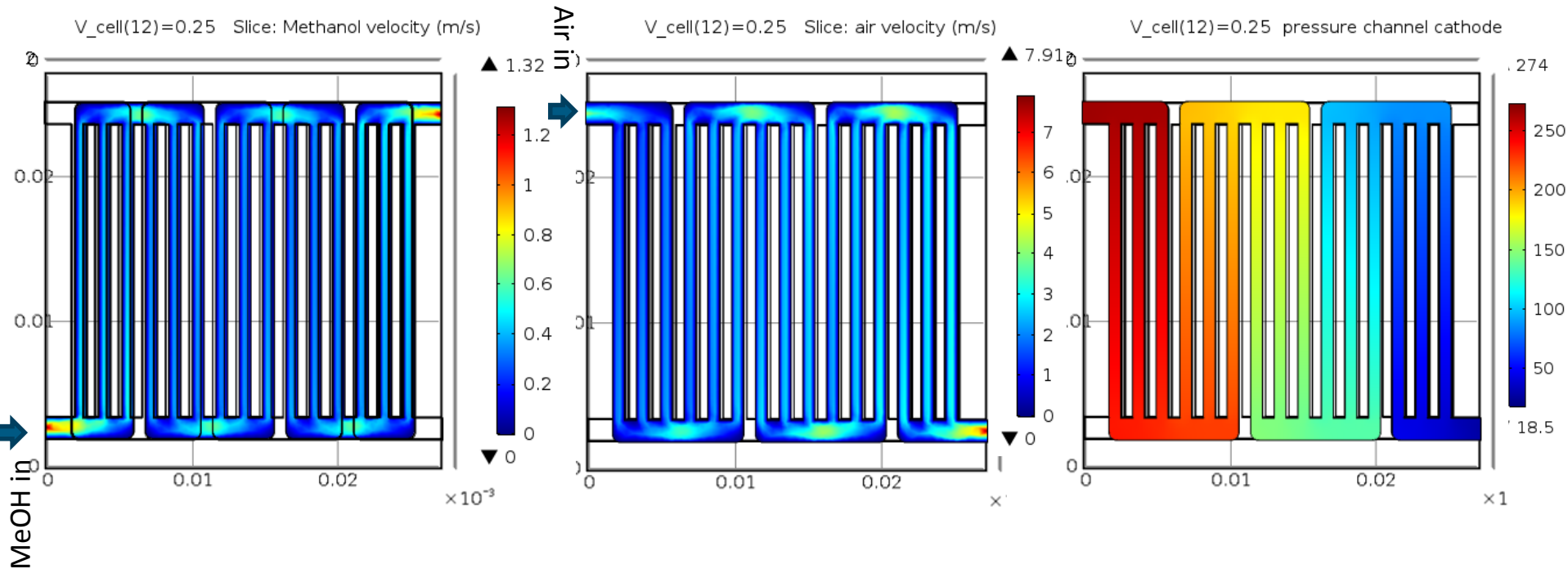

- Fluids velocity/Flow fields geometry should be adapted/optimized for better fuel repartition
- This is a laboratory cell; more complex geometry in prototypes are usually used

# Mass fraction distribution of reactants & products @ 0,25 V

V<sub>cell</sub>(12)=0.25 MeOH mass fraction anode channel

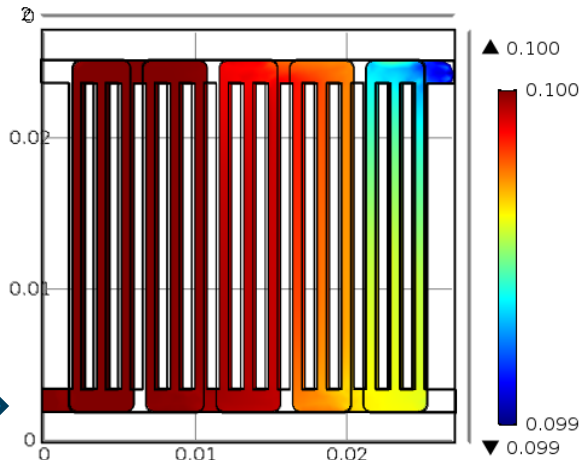

V<sub>cell</sub>(12)=0.25 Mass fraction CO<sub>2</sub> anode channel

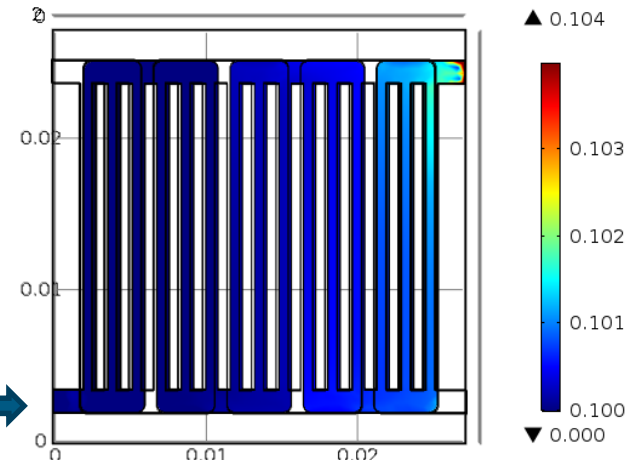

V<sub>cell</sub>(12)=0.25 Oxygen mass fraction cathode channel

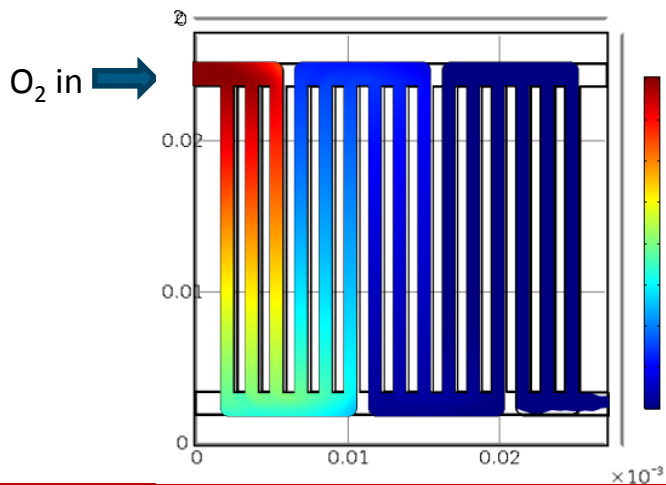

V<sub>cell</sub>(12)=0.25 H<sub>2</sub>O mass fraction channel cathode

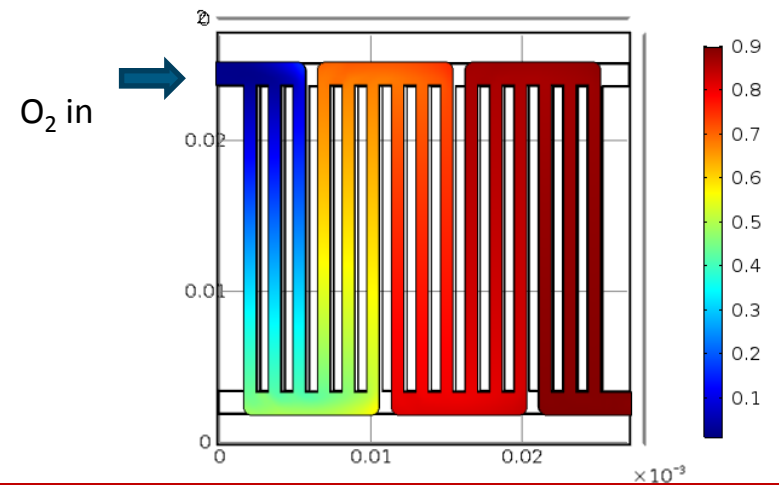

➤ No relevant MeOH mass transport limitation; H<sub>2</sub>O enrichment in cathode flow field channels

# Conclusions & acknowledgements

- Next step: model extension **with** air & electro-osmotic drag implementation, as well as model validation.

## Acknowledgements to

- Members of COMSOL Multiphysics support team,

- Project partners:



- & Financial support:



Project: 17955 BG/3

Thanks for your kind attention!