

Simulations of rolled-up optical microcavities using COMSOL

Shilong Li (李世龙)

National Laboratory for Infrared Physics
Shanghai Institute of Technical Physics
Chinese Academy of Sciences

Optical resonances

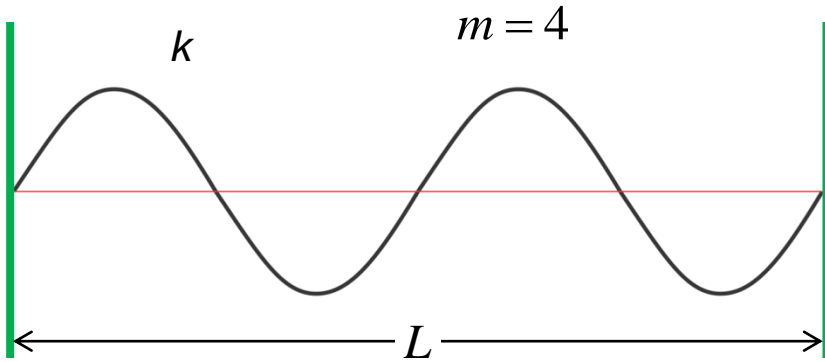

→ resonant modes:

$$k \cdot 2L = m \cdot 2\pi, \quad m = 1, 2, \dots$$

Optical resonances

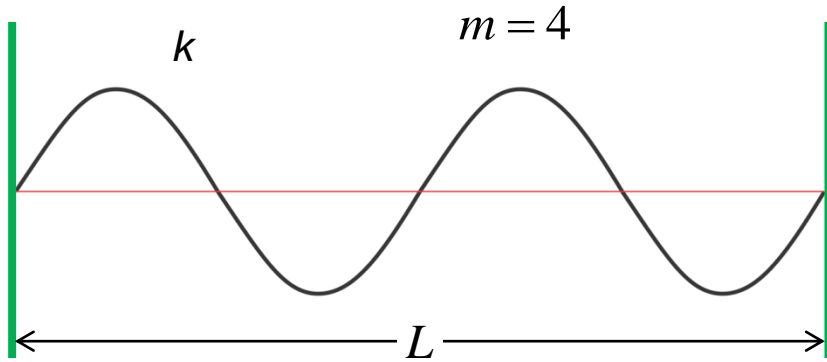

→ resonant modes:

$$k \cdot 2L = m \cdot 2\pi, \quad m = 1, 2, \dots$$

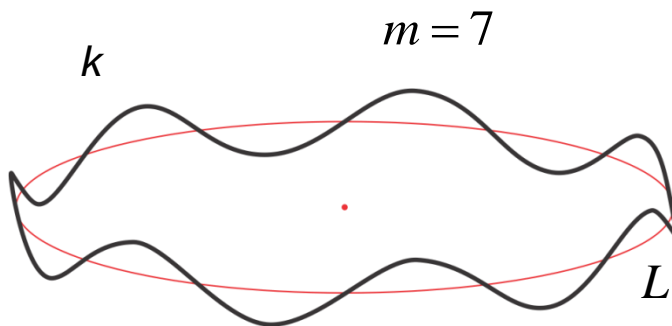

→ whispering gallery modes (WGMs):

$$k \cdot L = m \cdot 2\pi, \quad m = 1, 2, \dots$$

Optical resonances

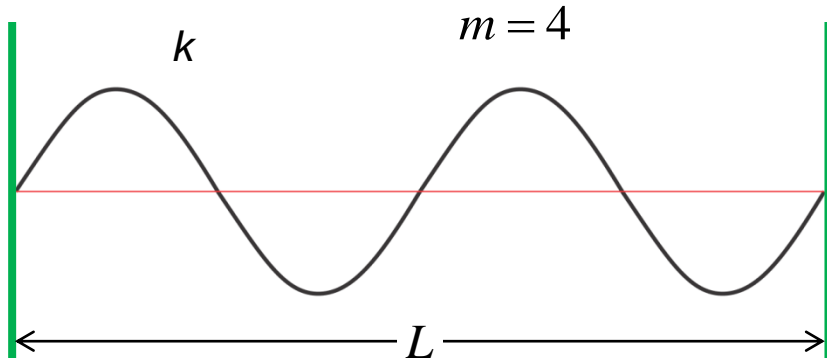

→ resonant modes:

$$k \cdot 2L = m \cdot 2\pi, \quad m = 1, 2, \dots$$

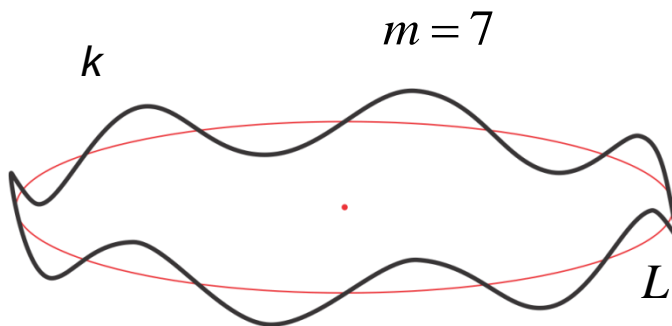

→ whispering gallery modes (WGMs):

$$k \cdot L = m \cdot 2\pi, \quad m = 1, 2, \dots$$

→ WGM optical microcavities (WGM OMs)

WGM optical microcavities

(a)

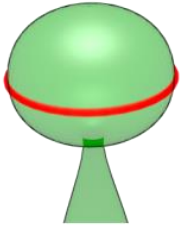

(b)

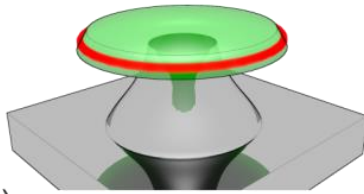

(c)

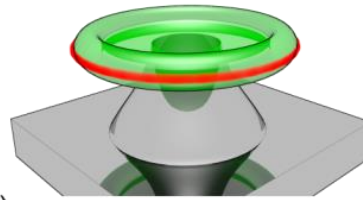

(d)

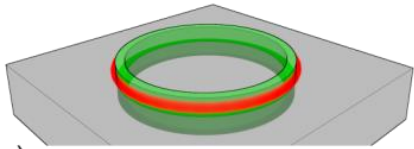

(e)

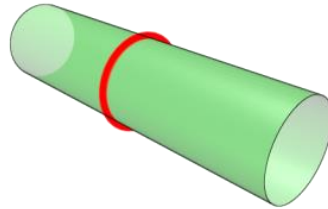

(f)

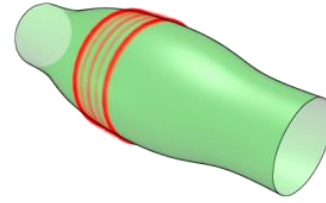

(g)

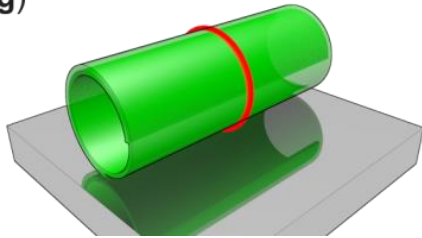

(h)

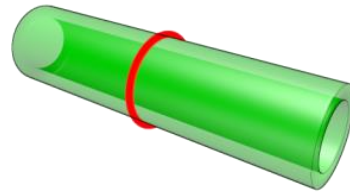

(i)

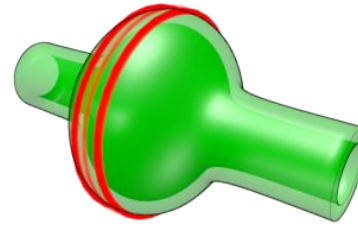

WGM optical microcavities

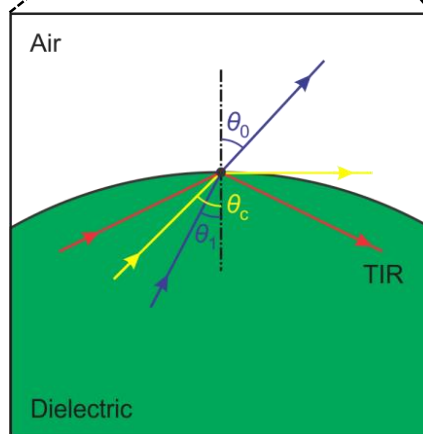
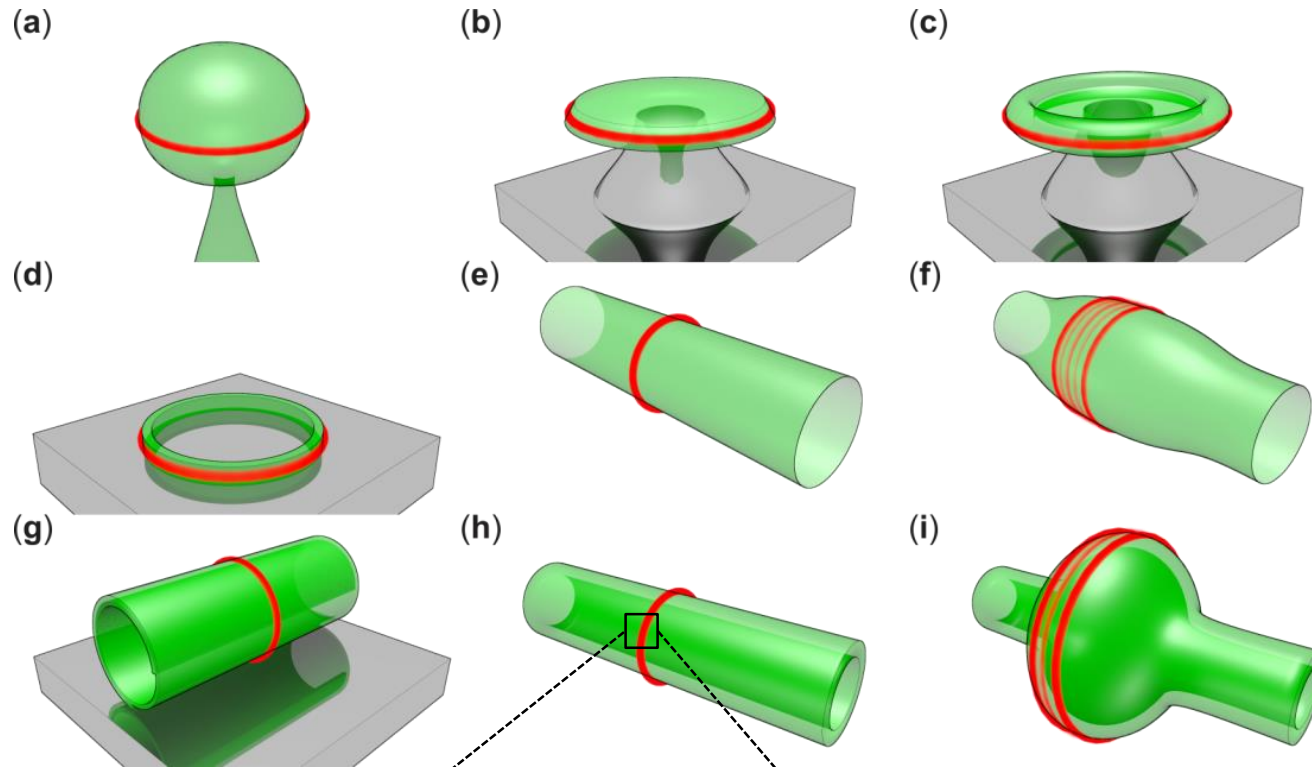

→ confined by total internal reflection (TIR):

$$n_{\text{eff}} \cdot k \cdot L + m \cdot \Theta_A = m \cdot 2\pi, \quad m = 1, 2, \dots$$

dynamic phase TIR phase

WGM optical microcavities

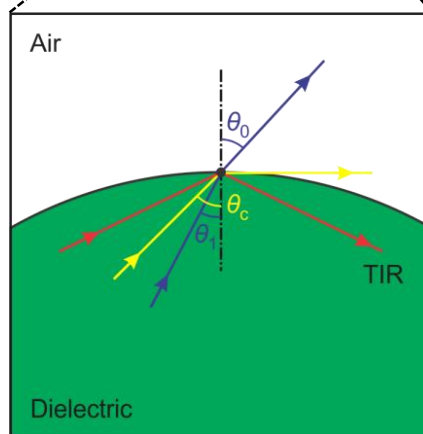
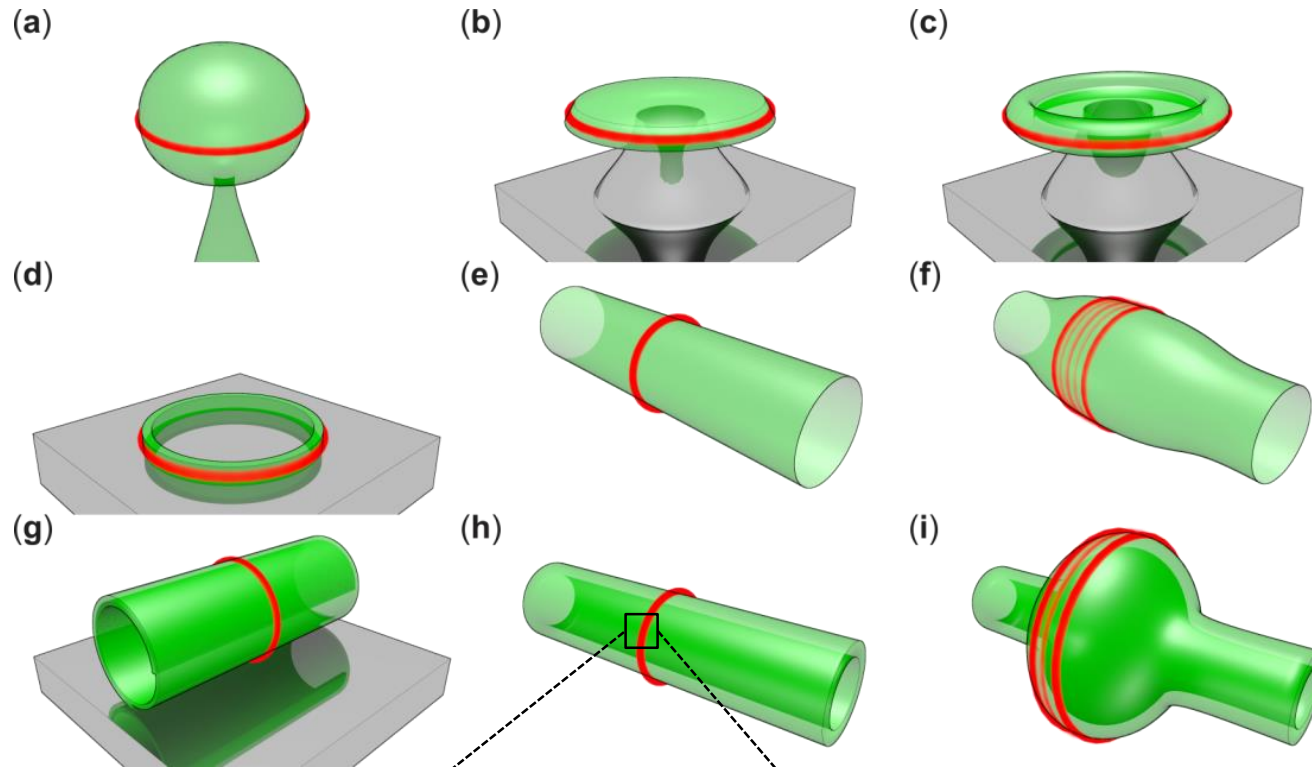

→ confined by total internal reflection (TIR):

$$n_{\text{eff}} \cdot k \cdot L + m \cdot \Theta_A = m \cdot 2\pi, \quad m = 1, 2, \dots$$

dynamic phase TIR phase

→ versatile applications:

cavity QED, (bio)sensors, photonic devices

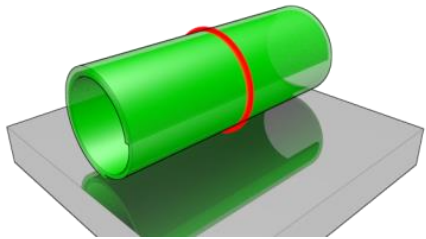

Rolled-up optical microcavities

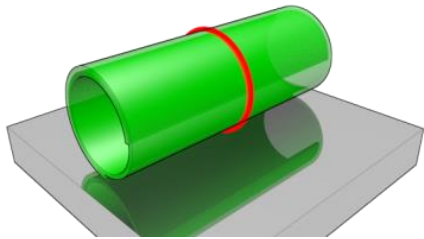

→ advantages using rolled-up WGM OMs:

on-chip [1]

arbitrary material [2-5]

hollow tubular geometry [1]

subwavelength wall thickness [6]

diverse structure

- [1] Y. F. Mei *et al.*, *Adv. Mater.* **20**, 4085 (2008).
- [2] S. Böttner *et al.*, *Opt. Lett.* **37**, 5136 (2012).
- [3] T. Kipp *et al.*, *Phys. Rev. Lett.* **96**, 077403 (2006).
- [4] R. Songmuang *et al.*, *Appl. Phys. Lett.* **90**, 091905 (2007).
- [5] J. Wang *et al.*, *Opt. Express* **20**, 18555 (2012).
- [6] S. M. Harazim *et al.*, *Lab Chip* **12**, 2649 (2012).

Rolled-up optical microcavities

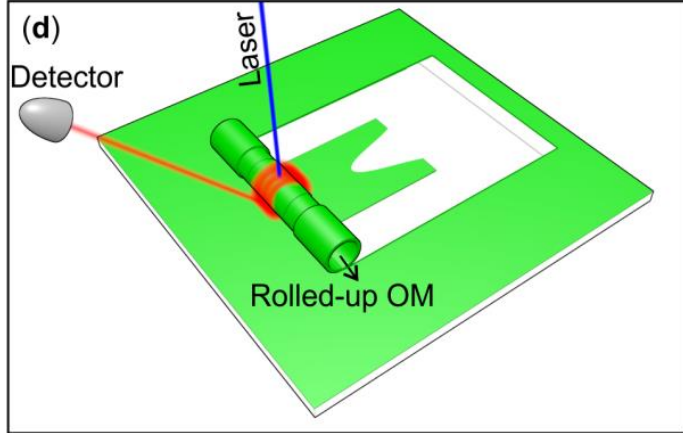
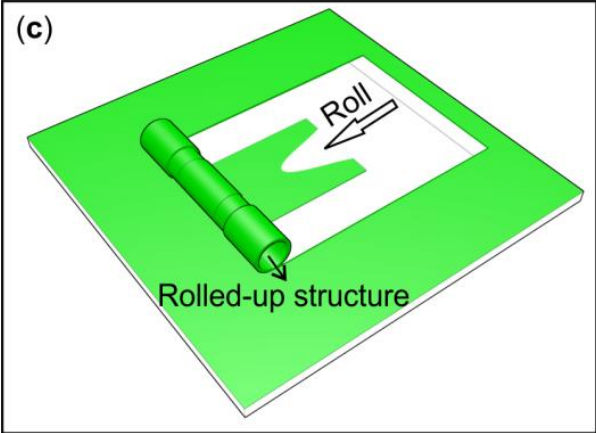
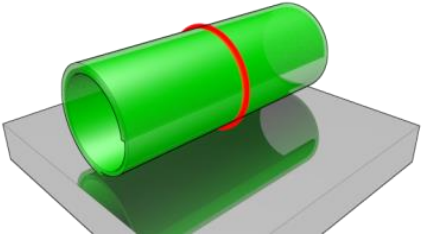
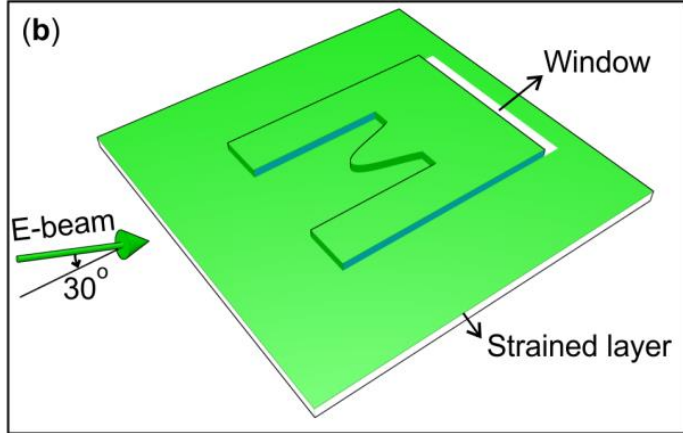
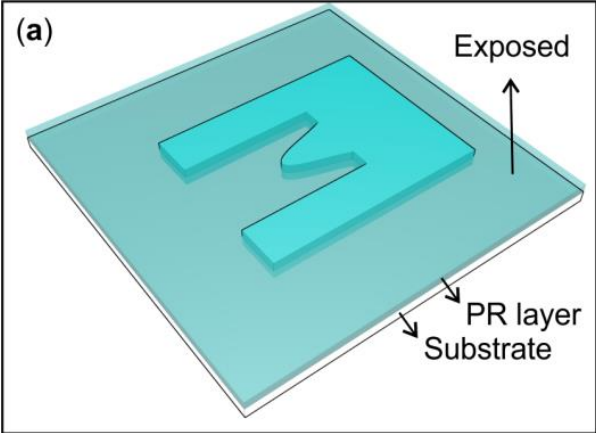

→ U-shaped pattern:
free-standing in the middle
axial confinement

Rolled-up optical microcavities

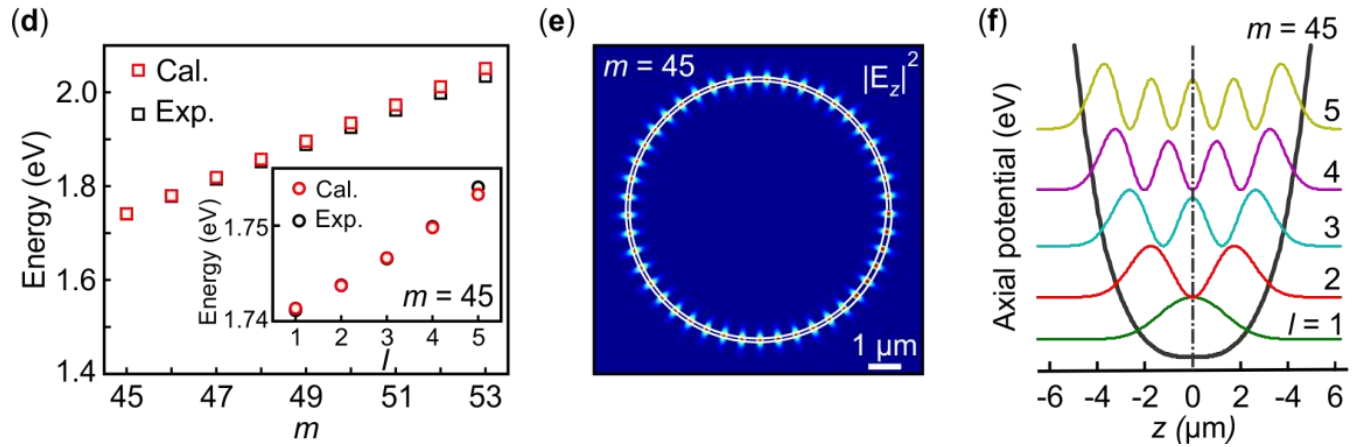
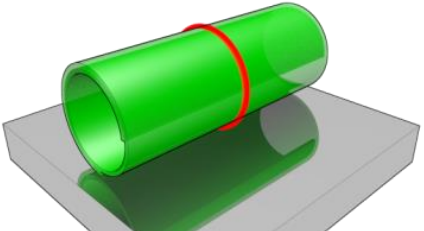
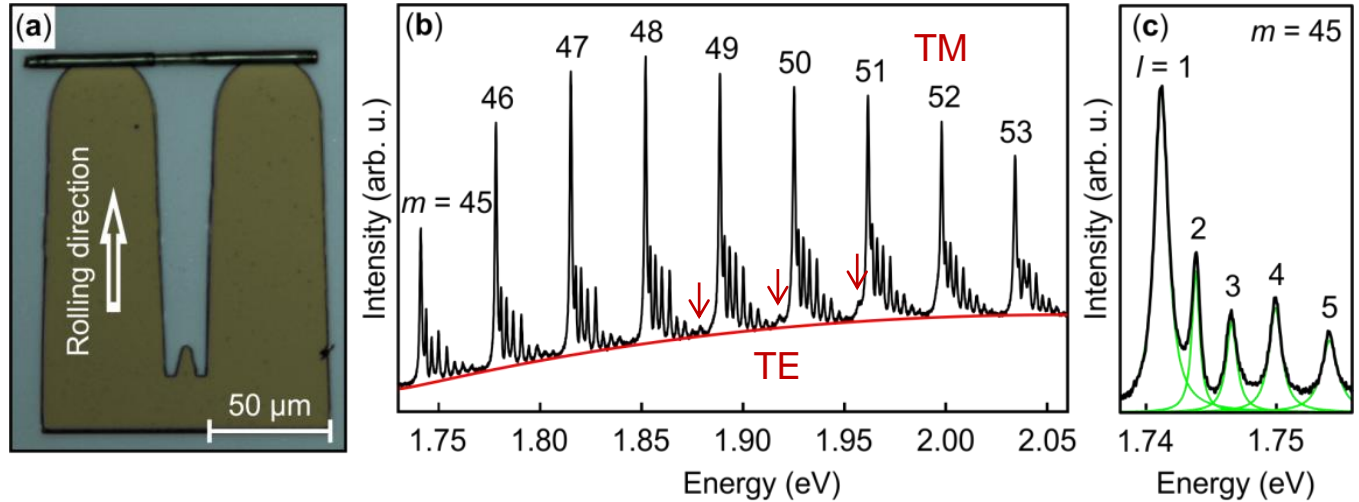

→ bilayer: 7 nm SiO_x and 28 nm SiO_2

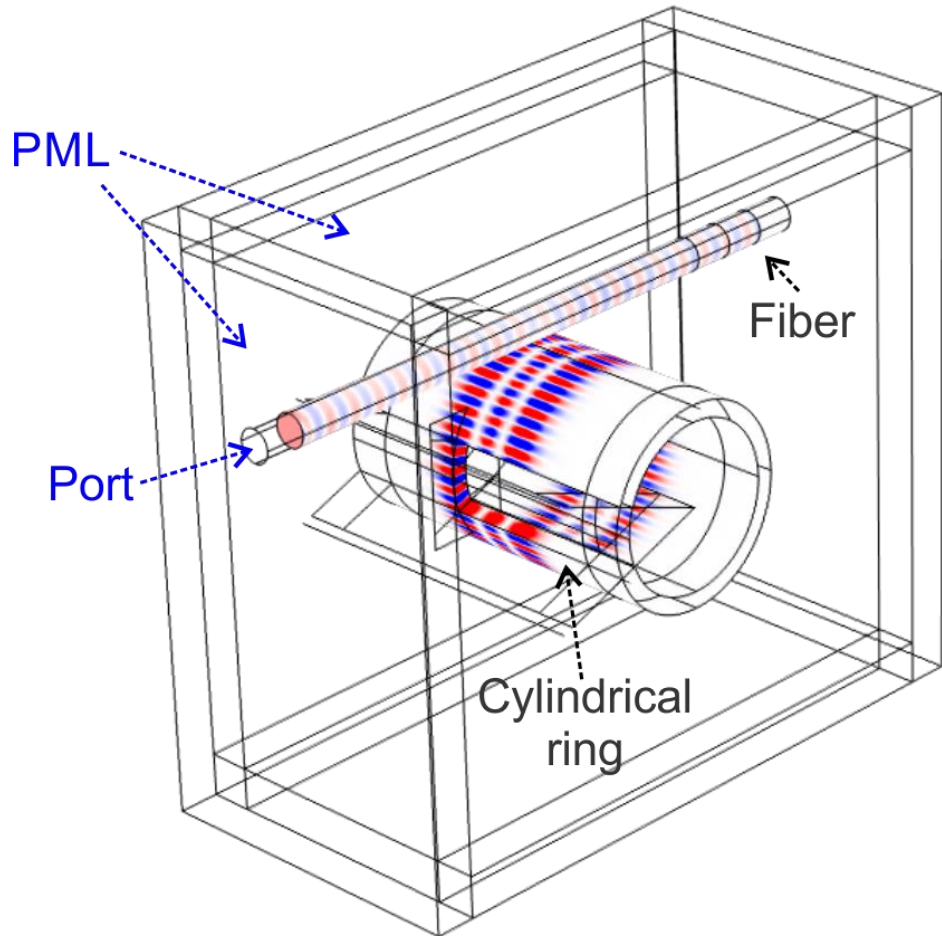
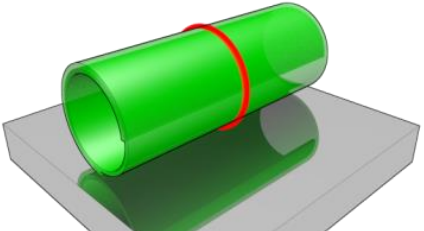

→ cylindrical ring approximation

(a) COMSOL with MATLAB

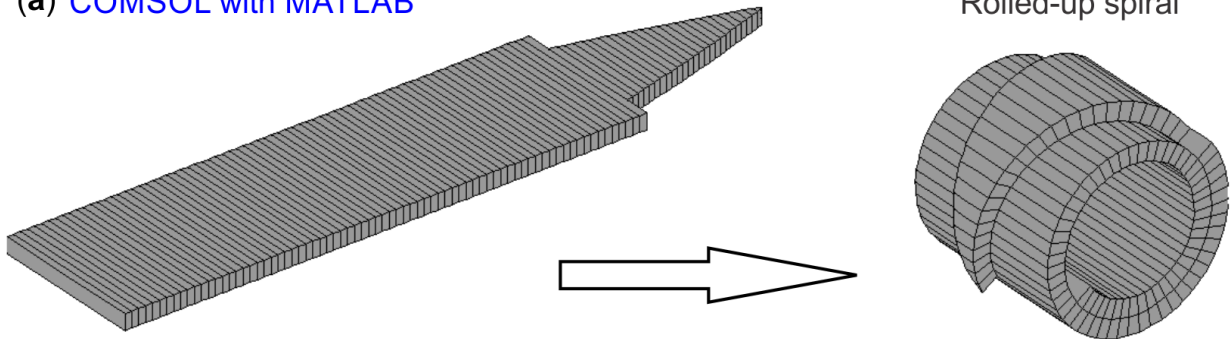

Rolled-up spiral

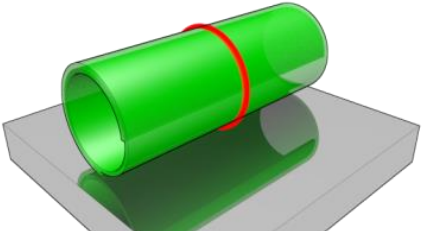

- rolled-up tubular structure
- **hexahedron3**

(a) COMSOL with MATLAB

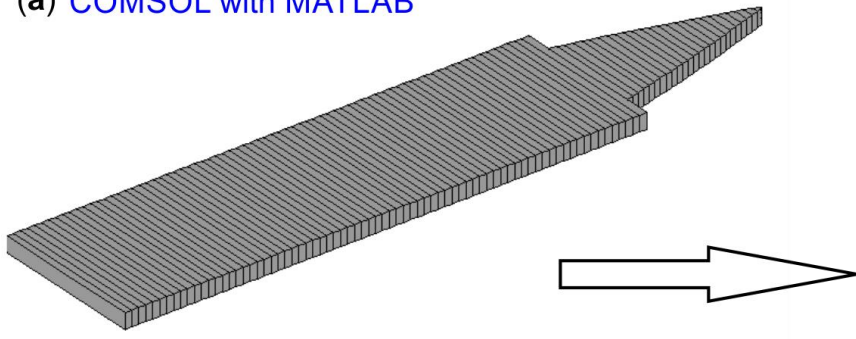

Rolled-up spiral

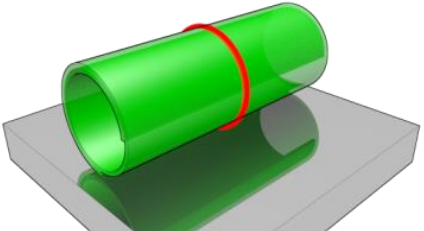
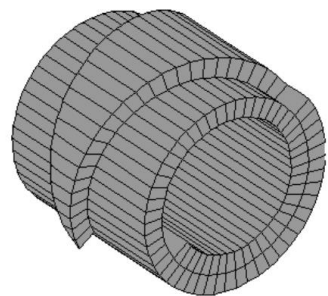

(b)

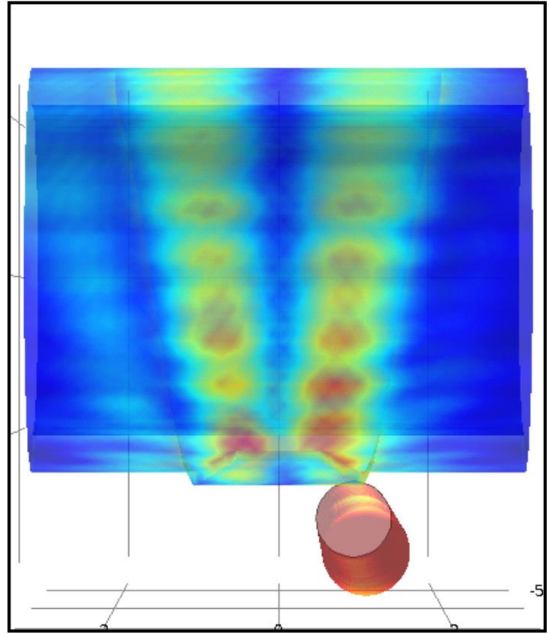
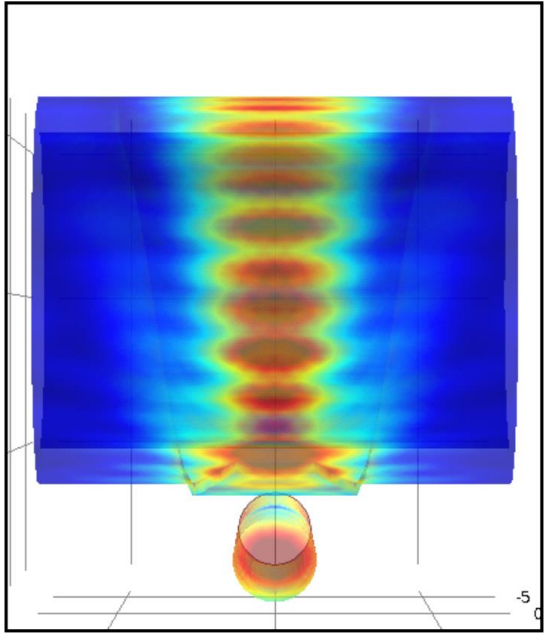

- CSC (China Scholarship Council)
- Prof. Oliver G. Schmidt
- Prof. Yongfeng Mei
- Dr. Suwit Kiravittaya
- Dr. Libo Ma
- Stefan Böttner
- Dr. Matthew Jorgensen
- Dr. Honglou Zhen
- Vladimir A. Bolanos Quinones
- Prof. Vladimir Fomin
- Yin Yin
- Members in IIN



Thank you very much for your attention!